



<b>Section</b>	<b>Contents</b>
<b>01F</b>	<b>Engine parts</b>
<b>02F</b>	<b>Fuel system</b>
<b>03F</b>	<b>Cooling system</b>
<b>04F</b>	<b>Air intake</b>
<b>05F</b>	<b>Exhaust system</b>
<b>06F</b>	<b>Clutch</b>
<b>07F</b>	<b>Gearbox</b>
<b>08F</b>	<b>Power take off</b>
<b>09F</b>	<b>Differential</b>
<b>10F</b>	<b>Hydraulic system</b>
<b>11F</b>	<b>Brake system</b>
<b>12F</b>	<b>Three point linkage</b>
<b>13F</b>	<b>Wheel nuts &amp; bolts</b>
<b>14F</b>	<b>Rims</b>
<b>15F</b>	<b>Front axle</b>
<b>16F</b>	<b>Steering system</b>
<b>17F</b>	<b>Instrumentation</b>
<b>18F</b>	<b>Electrical</b>
<b>19F</b>	<b>Grills</b>
<b>20F</b>	<b>Body Panels</b>
<b>21F</b>	<b>Seats</b>
	<b>Cross reference</b>

### Tractor & Engine Application Chart

Tractor	Cyl.	Bore	Cu. Inch	Litres	Tractor	Cyl.	Bore	Cu. Inch	Litres	Tractor	Cyl.	Bore	Cu. Inch	Litres			
Major	4	100	220	3.6	6600	4	111.76	256	4.2	8830	6T	111.76	401	6.6			
Super Major					6610			268	4.4	8870			456	7.5			
2606	3	106.68	158	2.6	6640	4T	111.76	304	5	8970	6T	100	220	3.6			
2310					6700			256	4.2	9000							
2600					6710			268	4.4	9200							
2610					6810			9600									
2810			175	2.9	6810			256	4.2	9700	4	104	237	3.9			
2910			158	2.6	7000			304	5	TL70							
3060			175	2.9	7010			268	4.4	TL80	4T	104	237	3.9			
3230			111.76	158	2.6			7600	256	4.2					TL90		
3430			106.68	175	2.9			7610	268	4.4	TL100	6	111.76	456	7.5		
3600								7700	256	4.2	TM115						
3610			111.76	192	3.2			7710	268	4.4	TM125	6T	111.76	456	7.5		
3900			106.68	175	2.9			7740	304	5	TM135						
3910			111.76	201	3.3			7810	6	111.76	401	6.6	TM150	4	104	237	3.9
3930								7840			401		6.6				
4080	7910	401				6.6	TN65F										
4100	106.68	183				3	8000	401			6.6		TN75F				
4110	111.76	201	3.3	8010	6	111.76	456	7.5	TN90F	4T	104	178	2.9				
4130				8160			401		6.6					TN55V/D/S			
4600				8200			401		6.6					TN65V/D/S			
4610				8210			401		6.6	TN75V/D/S	3T	104	304	5			
4630				8240			456		7.5	TS80							
4830				256			4.2		8260	456					7.5	TS90	
5000 (<3/68)	106.68	233	3.8	8340	6T	456	7.5	TS100	4T	111.76	456	7.5					
5000 (4/68<)	111.76	256	4.2	8340 Turbo	6T	401	6.6	TS110									
5030				8360	401	6.6	TS115	6	111.76	401	6.6						
5110	8530	456	7.5	TW5													
5600 (<9/80)	106.68	233	3.8	8560	6	456	7.5	TW10	6T	111.76	401	6.6					
5600 (10/80<)	111.76	256	4.2	8600	6	401	6.6	TW15									
5610				8630	401	6.6	TW20										
5640	268	4.4	8670	6T	456	7.5	TW25	6T	111.76	401	6.6						
5700	106.58	233	3.8	8700	6	401	6.6					TW30					
5900	111.76	268	4.4	8730	6T	111.76	401	6.6	TW35	6T	111.76	401	6.6				
6410				8770			456		7.5								

# PISTON SPECIFICATIONS

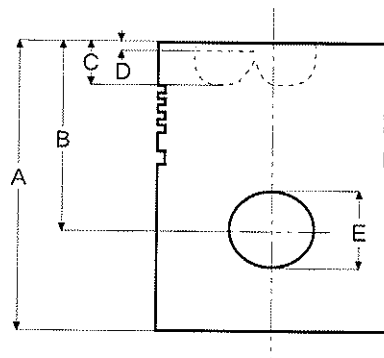
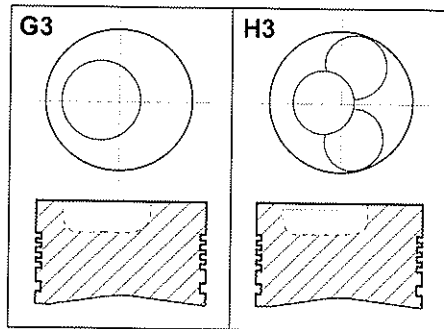
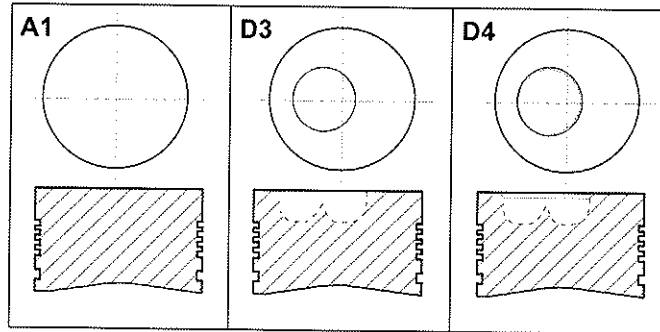

Denver Number	Bore Diameter	Bowl Type	A	B	C	D	E	Number Of Rings	
01F-2800	100	H3	118.10	71.03	24.61	1.65	31.75	5	
01F-2801				70.99			34.92		
01F-2802	106.68	G3	134.20	75.20	13.20	N/A	38.10	4	
01F-2803			129.18	70.18	17.28				
01F-2809			126.47	67.64	18.11				
01F-2804	111.76	D3	127.12	68.12	22.00				
01F-2810		19.82							
01F-2805		G3	129.55	70.55	18.50				
01F-2806			129.26	70.38	22.17				
01F-2811		D4	127.00	68.12	19.00				38.10
01F-2812		G3	126.75	67.87	18.92				41.27
01F-2813		D4	126.70	67.90	18.00				





	<p><b>01F- 150</b> Cylinder head bolt (Short) <i>D5NN6065C</i> 83907721</p>	<p>Major, Super Major, 2000, 2100, 2110, 2120, 2300, 2310, 2600, 2610, 3000, 3100, 3120, 3190, 3300, 3310, 3400, 3500, 3550, 3600, 3610, 4000, 4100, 4110, 4140, 4190, 4200, 4330, 4340, 4400, 4410, 4500, 4600, 4610, 5000, 5100, 5190, 5200, 5340, 5600, 5700, 6600, 7000, 7100, 7200, 7600, 7700, 8000, 8200, 8400, 8600, 8700, 9000, 9200, 9600, 9700, TW10, TW20, TW30</p>
	<p><b>01F- 151</b> Cylinder head bolt (Long) <i>D5NN6065D</i> 377489S</p>	<p>2000, 2100, 2110, 2120, 2300, 2310, 2600, 2610, 3000, 3100, 3120, 3190, 3300, 3310, 3400, 3500, 3550, 3600, 3610, 4000, 4100, 4110, 4140, 4190, 4200, 4330, 4340, 4400, 4410, 4500, 4600, 4610, 5000, 5100, 5190, 5200, 5340, 5600, 5700, 6600, 7000, 7100, 7200, 7600, 7700, 8000, 8200, 8400, 8600, 8700, 9000, 9200, 9600, 9700, TW10, TW20, TW30</p>
	<p><b>01F- 152</b> Cylinder head bolt (Long) <i>E3HN6065BA</i> 83948451</p>	<p>2810, 2910, 3230, 3610, 3910, 3930, 4110, 4130, 4610, 4630, 4830, 5030, 5110, 5610, 5640, 5900, 6410, 6610, 6640, 6710, 6810, 7010, 7410, 7610, 7710, 7740, 7810, 7840, 7910, 8010, 8160, 8210, 8240, 8340, 8360, 8530, 8560, 8630, 8670, 8730, 8770, 8830, 8870, 8970, TW5, TW15, TW25, TW35</p>
	<p><b>01F- 175</b> Injector gasket <i>C5NE9F596A</i></p>	<p>Most Models (Excluding Dexta &amp; Major)</p>
	<p><b>01F- 201</b> Valve spring <i>EIADDN6513</i> 81717773</p>	<p>Major, Super Major (1961 -)</p>
	<p><b>01F- 202</b> Valve spring <i>D6NN6513A</i> 83911693</p>	<p>2000, 2310, 2600, 2610, 2810, 2910, 3000, (3230, 3430 03/90&gt;09/91), 3600, 3610, 3900, 3910H, 3930H, 4000, 4100, 4110, (4130 06/94&gt;12/97 NHNA only), 4600, 4610, 4610H, (4830 07/90&gt;09/91), 5000, 5110, 5600, (5610 01/81&gt;09/91), 5700, 5900, 6410, 6600, (6610 01/81&gt;09/91), 6700, 6710, 6810, 7600 7610, 7700, 7710, 7810, 7910, 8000, 8200, 8210, 8530, 8600, (8630 03/90&gt;09/91), 8700, 8730, (8830 03/90&gt;09/91), 9000, 9700, TW5, TW10, TW15, TW20, TW25, TW30, TW35</p>

These parts are DENVER parts and are not manufactured by the Original Equipment Manufacturer. Original Manufacturers' names, part numbers and descriptions are quoted for reference purposes only and are not intended to indicate or suggest that our parts are made by the OEM.

**01F**



Tel : +27 (31) 5692823

Page 1

Fax : +27 (31) 5692947

**01F**



	<p><b>01F- 250</b> Valve retainer (Inlet) <i>D0NN6514A</i></p>	<p>2000, 2100, 2110, 2300, 2310, 2600, 2610, 2810, 3000, 3100, 3110, 3300, 3310, 3330, 3600, 3610, 4000, 4100, 4110, 4200, 4330, 4600, 4610, 4830, 5000, 5030, 5100, 5110, 5340, 5600, 5610, 5700, 6410, 6600, 6610, 6700, 7000, 7100, 7200, 7600, 7610, 7810, 8000, 8200, 8210, 8400, 8600, 9000, 9200, 9600, 9700, TW10, TW15, TW20, TW25, TW30, TW35</p>
	<p><b>01F- 251</b> Valve retainer (Exhaust) <i>C5NE6A516A</i></p>	<p>2000, 2100, 2110, 2300, 2310, 2600, 2610, 2810, 3000, 3100, 3110, 3300, 3310, 3330, 3600, 3610, 4000, 4100, 4110, 4200, 4330, 4600, 4610, 4830, 5000, 5030, 5100, 5110, 5340, 5600, 5610, 5700, 6410, 6600, 6610, 6700, 7000, 7100, 7200, 7600, 7610, 7810, 8000, 8200, 8210, 8400, 8600, 9000, 9200, 9600, 9700, TW10, TW15, TW20, TW25, TW30, TW35</p>
	<p><b>01F- 300</b> Valve stem seal <i>E0TA6571C</i></p>	<p>Fordson Major, Super Major</p>
	<p><b>01F- 301</b> Valve stem seal <i>C5NE6571A</i> <i>81804329</i></p>	<p>2000, 2310, 2600, 2610, 2810, 2910, 3000, 3230, 3430, 3600, 3900, 3910, 3930, 4000, 4100, 4110, 4130, 4600, 4610, 4630, 4830, 5000, 5030, 5110, 5600, 5610, 5700, 5900, 6410, 6600, 6610, 6700, 6710, 6810, 7000, 7410, 7600, 7610, 7700, 7710, 7810, 7910, 8000, 8200, 8210, 8530, 8600, 8630, 8700, 8730, 8830, 9000 (6/72), 9200 9600 9700, TW5, TW10, TW15, TW20, TW25, TW30, TW35</p>
	<p><b>01F- 400</b> Valve stem seal (Exhaust) <i>E0TA6571C</i></p>	<p>Fordson Major, Super Major</p>
	<p><b>01F- 401</b> Valve stem seal (Exhaust) <i>C5NE6571B</i> <i>81804330</i></p>	<p>2000, 2310, 2600, 2610, 2810, 2910, 3000, 3230, 3430, 3600, 3900, 3910, 3930, 4000, 4100, 4110, 4130, 4600, 4610, 4630, 4830, 5000, 5030, 5110, 5600, 5610, 5700, 5900, 6410, 6600, 6610, 6700, 6710, 6810, 7000, 7410, 7600, 7610, 7700, 7710, 7810, 7910, 8000, 8200, 8210, 8530, 8600, 8630, 8700, 8730, 8830, 9000 (6/72), 9200 9600 9700, TW5, TW10, TW15, TW20, TW25, TW30, TW35</p>

These parts are DENVER parts and are not manufactured by the Original Equipment Manufacturer. Original Manufacturers' names, part numbers and descriptions are quoted for reference purposes only and are not intended to indicate or suggest that our parts are made by the OEM.

**01F**







Tel : +27 (31) 5692823

Page 2

Fax : +27 (31) 5692947

**01F**



	<p><b>01F- 500</b> Valve cotter <i>EIADDN6518C</i></p>	<p>Fordson Major, Super Major</p>
	<p><b>01F- 501</b> Valve cotter <i>F2NN6518AA</i> 81876796</p>	<p>Suitable for 3, 4 &amp; 6 Cylinder Applications (Except for Major, Super Major)</p>
	<p><b>01F- 600</b> Inlet valve STD <i>EIADDN6507</i> <i>DDN6507</i></p>	<p>Major, Super Major</p>
	<p><b>01F- 601</b> Inlet valve STD <i>C5NN6507B</i> 81823823</p>	<p>2000, 3000, 4000, 5000, 8000, 8200, 8600 (9000 01/68&gt;05/72), (9200 01/69&gt;05/72), 9600</p>
	<p><b>01F- 601A</b> Inlet valve .003 <i>C5NN6507C</i></p>	<p>2000, 3000, 4000, 4100, 4110, 5000, 8000, 8200, 8600 (9000 01/01/68&gt;31/05/72), (9200 01/01/69&gt;31/05/72), 9600</p>
	<p><b>01F- 601B</b> Inlet valve .015 <i>C5NN6507D</i></p>	<p>2000, 300, 4000, 4100, 4110, 5000, 8000, 8200, 8600 (9000 01/68&gt;05/72), (9200 01/69&gt;05/72), 9600</p>

These parts are DENVER parts and are not manufactured by the Original Equipment Manufacturer. Original Manufacturers' names, part numbers and descriptions are quoted for reference purposes only and are not intended to indicate or suggest that our parts are made by the OEM.

**01F**







Tel : +27 (31) 5692823

Page 3

Fax : +27 (31) 5692947

**01F**









	<p><b>01F- 601C</b> Inlet valve .030 <i>C5NN6507E</i></p>	<p>2000, 3000, 4000, 4100, 4110, 5000, 8000, 8200, 8600 (9000 01/68&gt;05/72), (9200 01/69&gt;05/72), 9600</p>
	<p><b>01F- 602</b> Inlet valve STD <i>D8NN6507AB</i> <i>81865609</i></p>	<p>4130, 4630, 4830, 5030, 6610, 7000, 7500, 7600, 7610, 7700, 7710, 8630, 8730, 8830, (9000, 9200, 9600, 9700, 6/72 &gt;), TW15, TW20, TW25, TW30, TW35</p>
	<p><b>01F- 602A</b> Inlet valve .003 <i>D8NN6507BA</i></p>	<p>4130, 4630, 4830, 5030, 6610, 7000, 7500, 7600, 7610, 7700, 7710, 8630, 8730, 8830, (9000, 9200, 9600, 9700, 6/72 &gt;), TW15, TW20, TW25, TW30, TW35</p>
	<p><b>01F- 602B</b> Inlet valve .015 <i>D8NN6507CA</i></p>	<p>4130, 4630, 4830, 5030, 6610, 7000, 7500, 7600, 7610, 7700, 7710, 8630, 8730, 8830, (9000, 9200, 9600, 9700, 6/72 &gt;), TW15, TW20, TW25, TW30, TW35</p>
	<p><b>01F- 602C</b> Inlet valve .030 <i>D8NN6507DB</i></p>	<p>4130, 4630, 4830, 5030, 6610, 7000, 7500, 7600, 7610, 7700, 7710, 8630, 8730, 8830, (9000, 9200, 9600, 9700, 6/72 &gt;), TW15, TW20, TW25, TW30, TW35</p>
	<p><b>01F- 603</b> Inlet valve STD <i>D3NN6507A</i> <i>81842750</i></p>	<p>2310, 2600, 2610, 2810, 2910, 3230, 3430, 3600, 3610, 3900, 3910, 3910H, 3930, 3930H, 4130, 4600, 4610, 4610H, 4630, 5110, 5600, 5610, 5700, 5900, 6410, 6600, 6700, 6710, 6810, 7810, 7910, 8000, 8210, 8530, 8700, 9000, 9700, TW5, TW10</p>

These parts are DENVER parts and are not manufactured by the Original Equipment Manufacturer. Original Manufacturers' names, part numbers and descriptions are quoted for reference purposes only and are not intended to indicate or suggest that our parts are made by the OEM.





	<p><b>01F- 603A</b> Inlet valve .003 <i>D3NN6507B</i></p>	<p>2310, 2600, 2610, 2810, 2910, 3230, 3430, 3600, 3610, 3900, 3910, 3910H, 3930, 3930H, 4130, 4600, 4610, 4610H, 4630, 5110, 5600, 5610, 5700, 5900, 6410, 6600, 6700, 6710, 6810, 7810, 7910, 8000, 8210, 8530, 8700, 9000, 9700, TW5, TW10</p>
	<p><b>01F- 603B</b> Inlet valve .015 <i>D3NN6507C</i></p>	<p>2310, 2600, 2610, 2810, 2910, 3230, 3430, 3600, 3610, 3900, 3910, 3910H, 3930, 3930H, 4130, 4600, 4610, 4610H, 4630, 5110, 5600, 5610, 5700, 5900, 6410, 6600, 6700, 6710, 6810, 7810, 7910, 8000, 8210, 8530, 8700, 9000, 9700, TW5, TW10</p>
	<p><b>01F- 603C</b> Inlet valve .030 <i>D3NN6507D</i></p>	<p>2310, 2600, 2610, 2810, 2910, 3230, 3430, 3600, 3610, 3900, 3910, 3910H, 3930, 3930H, 4130, 4600, 4610, 4610H, 4630, 5110, 5600, 5610, 5700, 5900, 6410, 6600, 6700, 6710, 6810, 7810, 7910, 8000, 8210, 8530, 8700, 9000, 9700, TW5, TW10</p>
	<p><b>01F- 700</b> Exhaust valve STD <i>E1ADDN6505C</i> 81538372</p>	<p>Major, Super Major</p>
	<p><b>01F- 701</b> Exhaust valve STD <i>C7NN6505E</i> 81818709</p>	<p>2000, 3000, 4000, 4100, 4110, 5000, 8000, 8200, 8600, 9000, 9600</p>
	<p><b>01F- 701A</b> Exhaust valve .003 <i>C7NN6505F</i></p>	<p>2000, 3000, 4000, 4100, 4110, 5000, 8000, 8200, 8600, 9000, 9600</p>

These parts are DENVER parts and are not manufactured by the Original Equipment Manufacturer. Original Manufacturers' names, part numbers and descriptions are quoted for reference purposes only and are not intended to indicate or suggest that our parts are made by the OEM.

**01F**



Tel : +27 (31) 5692823

Page 5

Fax : +27 (31) 5692947

**01F**









	<p><b>01F- 701B</b> Exhaust valve .015 <i>C7NN6505G</i></p>	<p>2000, 3000, 4000, 4100, 4110, 5000, 8000, 8200, 8600, 9000, 9600</p>
	<p><b>01F- 701C</b> Exhaust valve .030 <i>C7NN6505H</i></p>	<p>2000, 3000, 4000, 4100, 4110, 5000, 8000, 8200, 8600, 9000, 9600</p>
	<p><b>01F- 702</b> Exhaust valve STD <i>D8NN6505AA</i> <i>83912598</i></p>	<p>4130, 4630, 4830, 5030, 6610, 7000, 7600, 7610, 7700, 7710, 8630, 8730, 8830, TW5, TW10, TW15, TW20, TW25, TW30, TW35</p>
	<p><b>01F- 702A</b> Exhaust valve .003 <i>D8NN6505BA</i></p>	<p>4130, 4630, 4830, 5030, 6610, 7000, 7600, 7610, 7700, 7710, 8630, 8730, 8830, TW5, TW10, TW15, TW20, TW25, TW30, TW35</p>
	<p><b>01F- 702B</b> Exhaust valve .015 <i>D8NN6505CA</i></p>	<p>4130, 4630, 4830, 5030, 6610, 7000, 7600, 7610, 7700, 7710, 8630, 8730, 8830, TW5, TW10, TW15, TW20, TW25, TW30, TW35</p>
	<p><b>01F- 702C</b> Exhaust valve .030 <i>D8NN6505DA</i></p>	<p>4130, 4630, 4830, 5030, 6610, 7000, 7600, 7610, 7700, 7710, 8630, 8730, 8830, TW5, TW10, TW15, TW20, TW25, TW30, TW35</p>

These parts are DENVER parts and are not manufactured by the Original Equipment Manufacturer. Original Manufacturers' names, part numbers and descriptions are quoted for reference purposes only and are not intended to indicate or suggest that our parts are made by the OEM.



# DENVER

	<p><b>01F- 703</b> Exhaust valve STD <i>D3NN6505A</i> 81843651</p>	<p>2310, 2600, 2610, 2810, 2910, 3230, 3430, 3600, 3900, 3910, 3930, 4100, 4110, 4130, 4600, 4610, 5600, 5700</p>
	<p><b>01F- 703A</b> Exhaust valve .003 <i>D3NN6505B</i></p>	<p>2310, 2600, 2610, 2810, 2910, 3230, 3430, 3600, 3900, 3910, 3930, 4100, 4110, 4130, 4600, 4610, 5600, 5700</p>
	<p><b>01F- 703B</b> Exhaust valve .015 <i>D3NN6505C</i></p>	<p>2310, 2600, 2610, 2810, 2910, 3230, 3430, 3600, 3900, 3910, 3930, 4100, 4110, 4130, 4600, 4610, 5600, 5700</p>
	<p><b>01F- 703C</b> Exhaust valve .030 <i>D3NN6505D</i></p>	<p>2310, 2600, 2610, 2810, 2910, 3230, 3430, 3600, 3900, 3910, 3930, 4100, 4110, 4130, 4600, 4610, 5600, 5700</p>
	<p><b>01F- 800</b> Valve guide <i>E1ADDN6510A</i> 81710777</p>	<p>Major, Super Major</p>
	<p><b>01F- 850</b> Rocker shaft assembly 3 Cyl.</p>	<p>Most 3 Cylinder models</p>

These parts are DENVER parts and are not manufactured by the Original Equipment Manufacturer. Original Manufacturers' names, part numbers and descriptions are quoted for reference purposes only and are not intended to indicate or suggest that our parts are made by the OEM.

**01F**

Tel : +27 (31) 5692823

Page 7

Fax : +27 (31) 5692947

**01F**



	<p><b>01F- 851</b> Rocker shaft assembly 4 Cyl.</p>	<p>Most 4 Cylinder Models:</p>
	<p><b>01F- 901</b> Rocker shaft 3 Cyl. <i>C5NE6563A</i></p>	<p>Most 3 Cylinder Models</p>
	<p><b>01F- 902</b> Rocker shaft 4 Cyl. <i>C5NE6563B</i></p>	<p>Most 4 Cylinder Models</p>
	<p><b>01F-1001</b> Rocker shaft pedestal <i>E4NN6531AA</i> <i>C7NN6531A</i></p>	<p>2000, 2100, 2110, 2300, 2310, 2600, 2610, 3000, 3100, 3300, 3310, 3330, 3600, 3610, 4000, 4100, 4110, 4200, 4330, 4340, 4600, 4610, 5000, 5100, 5110, 5200, 5340, 5600, 5610, 5700, 6600, 6610, 6700, 6710, 7000, 7100, 7200, 7600, 7610, 7710, 8200, 8400, 8600, 9000, 9200, 9600, TW10, TW20, TW30</p>
	<p><b>01F-1100</b> Rocker cover <i>E1ADKN6449A</i></p>	<p>Fordson Major</p>
	<p><b>01F-1101</b> Rocker cover <i>D3NN6582B</i> <i>C5NN6582B</i></p>	<p>2000, 2100, 2110, 3000, 3100, 3300, 3310, 3330, 4000, 4100, 4110, 4200, 4330, 4340</p>

These parts are DENVER parts and are not manufactured by the Original Equipment Manufacturer. Original Manufacturers' names, part numbers and descriptions are quoted for reference purposes only and are not intended to indicate or suggest that our parts are made by the OEM.

**01F**

Tel : +27 (31) 5692823

Page 8

Fax : +27 (31) 5692947

**01F**



	<p><b>01F-1102</b> Rocker cover <i>D3NN6582A</i></p>	<p>5000, 5100, 7000</p>
	<p><b>01F-1202</b> Rocker <i>C5NE6529A</i> <i>81804316</i></p>	<p>2000, 2310, 2600, 2610, 2810, 2910, 3000, 3230, 3430, 3600, 3610, 3900, 3910, 3930, 4000, 4100, 4130, 4600, 4610, 4630, 4830, 5000, 5030, 5110, 5600, 5610, 5640, 5700, 5900, 6410, 6600, 6610, 6640, 6700, 6710, 7010, 7740, 7840, 8240, 8340</p>
	<p><b>01F-1300</b> Rocker adjuster <i>E0TA6486</i></p>	<p>Fordson Major, Fordson Super Major</p>
	<p><b>01F-1301</b> Rocker adjuster <i>E7NN6549AA</i> <i>83963749</i></p>	<p>2000, 2310, 2600, 2610, 2810, 2910, 3000, 3230, 3430, 3600, 3610, 3900, 3910, 3930, 4000, 4100, 4130, 4600, 4610, 4630, 4830, 5000, 5030, 5110, 5600, 5610, 5700, 5900, 6410, 6600, 6610, 6700, 6710, 5640, 6640, 7010, 7740, TS80, TS90, TS100, TS110, 6810, 7000, 7410, 7600, 7610, 7700, 7710, 7810, 7910, 8000, 8200, 8210, 8530, 8600, 8630, 8700, 8730, 8830, 9000, 9200, 9600, 9700, TW5, TW10, TW15, TW20, TW25, TW30, TW35, 7810S, 7840, 8010, 8160, 8240, 8260, 8340, 8360, 8560, TM115, TM125, TM135, TM150, TM165, TS115</p>
	<p><b>01F-1401</b> Rocker shaft spring <i>C5NE6587A</i></p>	<p>2000, 2100, 2300, 2310, 2600, 2610, 2810, 3000, 3100, 3230, 3300, 3310, 3330, 3600, 3610, 3910, 3930, 4000, 4100, 4110, 4130, 4200, 4330, 4600, 4610, 4630, 4830, 5000, 5030, 5100, 5110, 5200, 5340, 5600, 5610, 5640, 5700, 5900, 6410, 6600, 6610, 6640, 6700, 6710, 6810, 7000, 7010, 7100, 7200, 7410, 7600, 7610, 7700, 7710, 7740, 7810, 7840, 7910, 8000, 8010, 8160, 8210, 8240, 8260, 8340, 8360, TW10, TW15, TW20, TW25, TW30, TW35</p>
	<p><b>01F-1500</b> Rocker shaft bush <i>C7NN6590A</i></p>	<p>2000, 2100, 2300, 2310, 2600, 2610, 2810, 3000, 3100, 3230, 3300, 3310, 3330, 3600, 3610, 3910, 3930, 4000, 4100, 4110, 4130, 4200, 4330, 4600, 4610, 4630, 4830, 5000, 5030, 5100, 5110, 5200, 5340, 5600, 5610, 5640, 5700, 5900, 6410, 6600, 6610, 6640, 6700, 6710, 6810, 7000, 7010, 7100, 7200, 7410, 7600, 7610, 7700, 7710, 7740, 7810, 7840, 7910, 8000, 8010, 8160, 8210, 8240, 8260, 8340, 8360, TW10, TW15, TW20, TW25, TW30, TW35</p>

These parts are DENVER parts and are not manufactured by the Original Equipment Manufacturer. Original Manufacturers' names, part numbers and descriptions are quoted for reference purposes only and are not intended to indicate or suggest that our parts are made by the OEM.

**01F**

Tel : +27 (31) 5692823

Page 9

Fax : +27 (31) 5692947

**01F**



	<p><b>01F-1600</b> Cam follower <i>DKN6489B</i></p>	<p>Major, Super Major</p>
	<p><b>01F-1601</b> Cam follower 2.25" <i>CSNE6500B</i> <i>83946434</i></p>	<p>2000, 2310, 2600, 2810, 2910, 3000, 3230, 3430, 3600, 3610, 3900, 3910, 3930, 4000, 4100, 4130, 4600, 4610, 4630, 4830, 5000, 5030, 5110, 5600, 5610, 5610S, 5640, 5700, 5900, 6410, 6600, 6610, 6610S, 6700, 6710, 6810, 7000, 7010, 7410, 7600, 7610, 7610S, 7740, 7700, 7710, 7810, 7810S, 7840, 7910, 8000, 8010, 8160, 8200, 8210, 8240, 8260, 8340, 8360, 8530, 8560, 8600, 8630, 8700, 8730, 8830, 9000, 9200, 9600, 9700, TW5, TW10, TW15, TW20, TW25, TW30, TW35, TS80, TS90, TS100, TS110, TS115, TM115, TM125, TM135, TM150, TM165</p>
	<p><b>01F-1602</b> Cam follower 2.06" <i>CSNE6500C2</i> <i>83946434</i></p>	<p>2000, 2310, 2600, 2610, 2810, 2910, 3000, 3230, 3430, 3600, 3610, 3900, 3910, 3910H, 3930, 3930H, 4000, 4100, 4110, 4130, 4600, 4610, 4610H, 4630, 4830, 5000, 5030, 5110, 5600, 5610, 5700, 5900, 6410, 6600, 6700, 6710, 6810, 7000, 7600, 7610, 7700, 7710, 7740, TS80, TS90, TS100, TS110, 7810, 7840, 7910, 8000, 8100, 8160, 8200, 8210, 8240, 8260, 8340, 8360, 8530, 8560, 8600, 8630, 8670, 8700, 8730, 8770, 8830, 9000, 9600, 9700, TW5, TW10, TW15, TW20, TW25, TW30, TW35</p>
	<p><b>01F-1700</b> Pushrod <i>ADN6488A</i></p>	<p>Fordson Major, Fordson Super Major</p>
	<p><b>01F-1702</b> Pushrod 12.17" <i>CSNE6567B</i></p>	<p>2000, 2310, 2600, 2610, 2810, 2910, 3000, 3230, 3430, 3600, 3610, 3900, 3910, 3930, 4000, 4100, 4130, 4600, 4610, 4630, 4830, 5000, 5030, 5110, 5600, 5610, 5700, 5900, 6410, 6600, 6610, 6700, 6710, 6810, 7000, 7410, 7600, 7610, 7700, 7710, 7810, 7910, 8210</p>
	<p><b>01F-1800</b> Camshaft (1 bolt hole) <i>528E6250D</i></p>	<p>Fordson Major, Fordson Super Major</p>

These parts are DENVER parts and are not manufactured by the Original Equipment Manufacturer. Original Manufacturers' names, part numbers and descriptions are quoted for reference purposes only and are not intended to indicate or suggest that our parts are made by the OEM.

	<p><b>01F-1801</b> Camshaft 3 Cyl. <i>C7NN 6250E</i> <i>81818394</i></p>	<p>2000, 2310, 2600, 2610, 2810, 2910, 3000, 3230, 3430, 3600, 3610, 3900, 3910, 3930, 4000, 4100, 4110, 4130, 4600, 4610, 4630</p>
	<p><b>01F-1802</b> Camshaft 4 Cyl. <i>E6TN6250AA</i> <i>81816551</i></p>	<p>4830, 5000, 5030, 5110, 5600, 5610, 5700, 5900, 6410, 6600, 6610, 6700, 6710, 6810, 7000, 7600, 7610, 7700, 7710 <i>C7NN6250B</i></p>
	<p><b>01F-1900</b> Camshaft gear outer (1 bolt hole) <i>E1ADDN6256A</i> <i>81710504</i></p>	<p>Fordson Major, Fordson Super Major</p>
	<p><b>01F-1901</b> Camshaft gear inner (1 bolt hole) <i>E70CP9</i></p>	<p>Fordson Major, Fordson Super Major</p>
	<p><b>01F-1903</b> Camshaft drive gear <i>E3NN6N251AB</i></p>	<p>2310, 2610, 2810, 2910, 3230, 3600, 3610, 3910, 3930, 4100, 4110, 4130, 4600, 4610, 4630, 4830, 5000, 5030, 5100, 5110, 5200, 5340, 5600, 5610, 5640, 5700, 5900, 6410, 6600, 6610, 6640, 6700, 6710, 6810, 7000, 7010, 7100, 7200, 7410, 7600, 7610, 7700, 7710, 7740, 7840, 8010, 8240, 8340</p>
	<p><b>01F-1904</b> Camshaft gear (For hyd pump drive) <i>E3NND855AA</i> <i>C5NND855B</i></p>	<p>2000, 2100, 2110, 2300, 2310, 2600, 2610, 2810, 2910, 3000, 3055, 3100, 3120, 3230, 3300, 3330, 3600, 3610, 3910, 3930, 4000, 4100, 4110, 4130, 4200, 4330, 4340, 4600, 4610, 4630, 4830, 5000, 5030, 5100, 5110, 5200, 5340, 5600, 5610, 5640, 5700, 6600, 6610, 6640, 6700, 6710, 6810, 7000, 7010, 7100, 7200, 7410, 7600, 7610, 7700, 7710, 7740, 7810, 7840, 7910, 8010, 8160, 8210, 8240, 8260, 8340, 8360</p>

These parts are DENVER parts and are not manufactured by the Original Equipment Manufacturer. Original Manufacturers' names, part numbers and descriptions are quoted for reference purposes only and are not intended to indicate or suggest that our parts are made by the OEM.

	<p><b>01F-1910</b></p> <p>Cover (For pump gear)</p> <p><i>C5NND851B</i></p>	<p>2000, 2100, 2110, 2300, 2310, 2600, 2610, 2810, 3000, 3100, 3230, 3300, 3310, 3330, 3600, 3610, 3910, 3930, 4000, 4100, 4110, 4130, 4200, 4330, 4600, 4610, 4630, 4830, 5000, 5030, 5100, 5110, 5200, 5340, 5600, 5610, 5700, 5900, 6410, 6600, 6610, 6700, 6710, 6810, 7000, 7010, 7100, 7200, 7410, 7600, 7610, 7700, 7710, 7810, 7910, 8000, 8210, TW10, TW15, TW20, TW25, TW30, TW35</p>
	<p><b>01F-1911</b></p> <p>O-ring for cover</p> <p><i>87095S94</i></p> <p><i>87095S91</i></p>	<p>2000, 2100, 2110, 2300, 2310, 2600, 2610, 2810, 3000, 3100, 3230, 3300, 3310, 3330, 3600, 3610, 3910, 3930, 4000, 4100, 4110, 4130, 4200, 4330, 4600, 4610, 4630, 4830, 5000, 5030, 5100, 5110, 5200, 5340, 5600, 5610, 5700, 5900, 6410, 6600, 6610, 6700, 6710, 6810, 7000, 7010, 7100, 7200, 7410, 7600, 7610, 7700, 7710, 7810, 7910, 8000, 8210, TW10, TW15, TW20, TW25, TW30, TW35</p>
	<p><b>01F-1915</b></p> <p>Cover, Power steering pump 81/</p> <p><i>C5NE3B681A</i></p> <p><i>81803219</i></p>	<p>2000, 2100, 2110, 2300, 2310, 2600, 2610, 2810, 2910, 3000, 3055, 3100, 3230, 3300, 3310, 3330, 3600, 3610, 3910, 3930, 4000, 4100, 4110, 4130, 4200, 4330, 4600, 4610, 4630, 4830, 5000, 5030, 5100, 5110, 5200, 5340, 5600, 5610, 5640, 5700, 5900, 6410, 6600, 6610, 6640, 6700, 6710, 6810, 7000, 7010, 7100, 7200, 7410, 7600, 7610, 7700, 7710, 7740, 7810, 7840, 7910, 8000, 8010, 8160, 8210, 8240, 8260, 8340, 8360, 8670, 8730</p>
	<p><b>01F-1950</b></p> <p>Thrust plate (For gear)</p> <p><i>E5HN6269AA</i></p> <p><i>D8NN6269AA</i></p>	<p>2600, 2610, 2810, 2910, 3600, 3610, 3910, 4100, 4110, 4600, 4610, 5110, 5600, 5610, 5640, 5700, 5900, 6410, 6600, 6610, 6640, 6700, 6710, 6810, 7410, 7600, 7610, 7700, 7740, 7710, 7810, 7840, 7910, 8000, 8200, 8210, 8240, 8260, 8340, 8400, 8530, 8630, 8700, 8730, 8830, 9000, 9200, 9600, 9700, TW5, TW10, TW15, TW20, TW25, TW30, TW35</p>
	<p><b>01F-2001</b></p> <p>Camshaft idler gear</p> <p><i>E3NN6A253AB</i></p>	<p>2000, 2100, 2110, 2300, 2310, 2600, 2610, 2810, 2910, 3000, 3100, 3230, 3330, 3430, 3600, 3610, 3910, 3930, 4000, 4100, 4110, 4130, 4200, 4330, 4340, 4600, 4610, 4630, 4830, 5000, 5030, 5100, 5110, 5200, 5340, 5600, 5610, 5640, 5700, 6410, 6600, 6610, 6640, 6700, 6710, 7000, 7600, 7610, 7700, 7710, 7740, 7810, 7840, 8010, 8240, 8340</p>
	<p><b>01F-2100</b></p> <p>Camshaft bush</p> <p><i>C5NE6261B</i></p> <p><i>81810777</i></p>	<p>2000, 2310, 2600, 2610, 810, 2910, 3000, 3230, 3430, 3600, 3610, 3900, 3910, 3910H, 3930, 39309H, 4000, 4100, 4110, 4130, 4600, 4610, 4610H, 4630, 4830, 5000, 5030, 5110, 5600, 5610, 5700, 5900, 6410, 6600, 6610, 6700, 6710, 6810, 7000, 7600, 7610, 7700, 7710, 7740, TS80, TS90, TS100, TS110, 7810, 7840, 7910, 8000, 8100, 8160, 8200, 8210, 8240, 8260, 8340, 8360, 8530, 8560, 8600, 8630, 8670, 8700, 8730, 8770, 8830, 9000, 9600, 9700, TW5, TW10, TW15, TW20, TW25, TW30, TW35</p>

These parts are DENVER parts and are not manufactured by the Original Equipment Manufacturer. Original Manufacturers' names, part numbers and descriptions are quoted for reference purposes only and are not intended to indicate or suggest that our parts are made by the OEM.



	<p><b>01F-2350</b> Welsh engine plug 28.1mm <i>390624S</i></p>	<p>Various</p>
	<p><b>01F-2351</b> Welsh engine plug 38.1mm <i>390628S</i></p>	<p>Various</p>
	<p><b>01F-2352</b> Welsh engine plug 44.7mm <i>390628S</i></p>	<p>Various</p>
	<p><b>01F-2375</b> Cylinder block rear plate <i>E5NN6A373AB</i> <i>C7NN6A373B</i></p>	<p>2000, 2100, 2110, 2150, 2300, 2310, 2600, 2610, 2810, 2910, 3000, 3055, 3100, 3300, 3310, 3330, 3600, 3610, 3910, 4000, 4100, 4110, 4200, 4330, 4340, 4600, 4610, 4830, 5000, 5030, 5100, 5200, 5340, 5600, 5610, 5900, 6600, 6610, 6700, 7000, 7100, 7200, 7410, 7600, 7610, 7700, 7710, 7810, 7910, 8210, 8530, 8630, 8730, 8830, TW5, TW15, TW25, TW35</p>
	<p><b>01F-2380</b> Gasket for rear plate <i>C7NN6N008A</i></p>	<p>2000, 2100, 2110, 2150, 2300, 2310, 2600, 2610, 2810, 2910, 3000, 3055, 3100, 3110, 3150, 3300, 3310, 3330, 3400, 3600, 3610, 3900, 3910, 4000, 4100, 4110, 4200, 4330, 4340, 4600, 4610, 5000, 5100, 5110, 5200, 5340, 5600, 5610, 5700, 5900, 6410, 6600, 6610, 6700, 6710, 6810, 7000, 7100, 7200, 7410, 7600, 7610, 7710, 7810, 7910, 8000, 8200, 8210, 8400, 8530, 8600, 8630, 8700, 8730, 8830, 9000, 9200, 9600, 9700, TW5, TW10, TW15, TW20, TW25, T30, TW35</p>
	<p><b>01F-2401</b> Conrod <i>E3HN6200AC42</i> <i>81864279</i></p>	<p>2000, 2310, 2600, 2610, 2810, 2910, 3000, 3600, 3610, 3910, 4000, 4100, 4110, 4600, 4610, 8000, 8200, 8600, 8700, TW10  (8/90&gt;)  4130, 3230, 3430, 3930, 4630, 5110, 5610, 5900, 6410, 6610, 6710, 6810, 7000, 7410, 7600, 7610, 7700, 7710, 7810, 7910, 8210, 8530, 8630, 8730, 8830, TW5, TW15, TW25, TW35</p>

These parts are DENVER parts and are not manufactured by the Original Equipment Manufacturer. Original Manufacturers' names, part numbers and descriptions are quoted for reference purposes only and are not intended to indicate or suggest that our parts are made by the OEM.

	<p><b>01F-2500</b></p> <p>Conrod bush (Fordson Major)</p> <p><i>E1ADDN6207</i></p> <p><i>81710453</i></p>	<p>Fordson Major, Fordson Super Major</p>
	<p><b>01F-2501</b></p> <p>Conrod bush</p> <p><i>C5NE6207A</i></p> <p><i>81803972</i></p>	<p>2000, 2310, 2600, 2610, 2810, 2910, 3000, 3600, 3610, 3910, 4000, 4100, 4110, 4600, 4610, 8000, 8200, 8600, 8700, TW10</p> <p>(8/90&gt;)</p> <p>4130, 3230, 3430, 3930, 4630, 5110, 5610, 5900, 6410, 6610, 6710, 7810, 7910, 8210, 8530, 8630, 8730, 8830, TW5, TW15, TW25, TW35</p>
	<p><b>01F-2600</b></p> <p>Conrod bolt (Fordson Major)</p> <p><i>E1ADDN6215</i></p> <p><i>81710483</i></p>	<p>Fordson Major, Fordson Super Major</p>
	<p><b>01F-2601</b></p> <p>Conrod bolt (Most models)</p> <p><i>E4TN6214AB</i></p> <p><i>83996584</i></p>	<p>2000, 2310, 2600, 2610, 2810, 2910, 3000, 3600, 3610, 3910, 4000, 4100, 4110, 4600, 4610, 8000, 8200, 8600, 8700, TW10</p> <p>(8/90&gt;)</p> <p>4130, 3230, 3430, 3930, 4630, 5110, 5610, 5900, 6410, 6610, 6710, 6810, 7000, 7410, 7600, 7610, 7700, 7710, 7810, 7910, 8210, 8530, 8630, 8730, 8830, TW5, TW15, TW25, TW35</p>
	<p><b>01F-2700</b></p> <p>Conrod nut</p> <p><i>385279S2</i></p> <p><i>39065552</i></p>	<p>Major, Super Major, Dexta, Super Dexta, 2000, 2310, 2600, 2610, 2810, 2910, 3000, 3600, 3610, 3910, 4000, 4100, 4110, 4600, 4610, 8000, 8200, 8600, 8700, TW10</p> <p>(8/90&gt;)</p> <p>4130, 3230, 3430, 3930, 4630, 5110, 5610, 5900, 6410, 6610, 6710, 6810, 7000, 7410, 7600, 7610, 7700, 7710, 7810, 7910, 8210, 8530, 8630, 8730, 8830, TW5, TW15, TW25, TW35</p>
	<p><b>01F-2800</b></p> <p>Piston &amp; pin (32mm pin)</p> <p><i>E1ADDN6102G</i></p> <p><i>81710364</i></p>	<p>Fordson Major, Fordson Super Major (&lt;4/57)</p>

These parts are DENVER parts and are not manufactured by the Original Equipment Manufacturer. Original Manufacturers' names, part numbers and descriptions are quoted for reference purposes only and are not intended to indicate or suggest that our parts are made by the OEM.



	<p><b>01F-2801</b></p> <p>Piston &amp; pin (35mm pin)</p> <p><i>E1ADDN6102J</i></p> <p>81710365</p>	<p>Fordson Major, Fordson Super Major (4/57&lt;)</p>
	<p><b>01F-2802</b></p> <p>Piston &amp; pin STD. (4.2" / 106.68mm)</p> <p><i>C7NN6108S</i></p> <p>81817242</p>	<p>2000</p>
	<p><b>01F-2802B</b></p> <p>Piston &amp; pin 020 (4.2" / 106.68mm)</p> <p><i>D6NN6108H</i></p> <p>83910839</p>	<p>2000</p>
	<p><b>01F-2802C</b></p> <p>Piston &amp; pin 030 (4.2" / 106.68mm)</p> <p><i>D6NN6108J</i></p>	<p>2000</p>
	<p><b>01F-2802D</b></p> <p>Piston &amp; pin 040 (4.2" / 106.68mm)</p> <p><i>D6NN6108K</i></p>	<p>2000</p>
	<p><b>01F-2803</b></p> <p>Piston &amp; pin STD. (4.2" / 106.68mm)</p> <p><i>D6NN6108L</i></p> <p>81845870</p>	<p>3000 (01/65&gt;12/74), 3600 (01/75&gt;12/81) 3900 (01/75&gt;12/81), 5000 (01/65&gt;03/68) 5600 (01/75&gt;12/81), 5700 (01/75&gt;09/80)</p>

These parts are DENVER parts and are not manufactured by the Original Equipment Manufacturer. Original Manufacturers' names, part numbers and descriptions are quoted for reference purposes only and are not intended to indicate or suggest that our parts are made by the OEM.



	<p><b>01F-2803B</b></p> <p>Piston &amp; pin 020 (4.2" / 106.68mm)</p> <p><i>D6NN6108N</i></p> <p>81845872</p>	<p>3000 (01/65&gt;12/74), 3600 (01/75&gt;12/81) 3900 (01/75&gt;12/81), 5000 (01/65&gt;03/68) 5600 (01/75&gt;12/81), 5700, (01/75&gt;09/80)</p>
	<p><b>01F-2803C</b></p> <p>Piston &amp; pin 030 (4.2" / 106.68mm)</p> <p><i>D6NN6108P</i></p> <p>81845873</p>	<p>3000 (01/65&gt;12/74), 3600 (01/75&gt;12/81) 3900 (01/75&gt;12/81), 5000 /01/65&gt;03/68) 5600 (01/75&gt;12/81), 5700, (01/75&gt;09/80),</p>
	<p><b>01F-2803D</b></p> <p>Piston &amp; pin 040 (4.2" / 106.68mm)</p> <p><i>D6NN6108R</i></p> <p>81845874</p>	<p>3000 (01/65&gt;12/74), 3600 (01/75&gt;12/81) 3900 (01/75&gt;12/81), 5000 /01/65&gt;03/68) 5600 (01/75&gt;12/81), 5700, (01/75&gt;09/80)</p>
	<p><b>01F-2804</b></p> <p>Piston &amp; pin STD. (4.4" / 111.76mm)</p> <p><i>E4NN6108T</i></p> <p>81827165</p>	<p>4000, 8000 (&gt;9/72), 8200</p>
	<p><b>01F-2804B</b></p> <p>Piston &amp; pin 020 (4.4" / 111.76mm)</p> <p><i>E0NN6108CA</i></p> <p>81827167</p>	<p>4000, 8000 (&gt;9/72), 8200</p>
	<p><b>01F-2804C</b></p> <p>Piston &amp; pin 030 (4.4" / 111.76mm)</p> <p><i>D2NN6108AF</i></p> <p>81827168</p>	<p>4000, 8000 (&gt;9/72), 8200</p>

These parts are DENVER parts and are not manufactured by the Original Equipment Manufacturer. Original Manufacturers' names, part numbers and descriptions are quoted for reference purposes only and are not intended to indicate or suggest that our parts are made by the OEM.



	<p><b>01F-2804D</b></p> <p>Piston &amp; pin 040 (4.4\"/&gt; </p>	<p>4000, 8000 (&gt;9/72), 8200</p>
	<p><b>01F-2805</b></p> <p>Piston &amp; pin STD. (4.4\"/&gt; </p>	<p>5000 (04/68&lt;), 5110 (&lt;07/87), 5600 (10/80&lt;), 5610 (&lt;07/87), 5900 (&lt;07/87), 6600 (&lt;09/80), 6700 (&lt;09/80)</p>
	<p><b>01F-2805B</b></p> <p>Piston &amp; pin 020 (4.4\"/&gt; </p>	<p>5000 (04/68&lt;), 5110 (&lt;07/87), 5600 (10/80&lt;), 5610 (&lt;07/87), 5900 (&lt;07/87), 6600 (&lt;09/80), 6700 (&lt;09/80)</p>
	<p><b>01F-2805C</b></p> <p>Piston &amp; pin 030 (4.4\"/&gt; </p>	<p>5000 (04/68&lt;), 5110 (&lt;07/87), 5600 (10/80&lt;), 5610 (&lt;07/87), 5900 (&lt;07/87), 6600 (&lt;09/80), 6700 (&lt;09/80)</p>
	<p><b>01F-2805D</b></p> <p>Piston &amp; pin 040 (4.4\"/&gt; </p>	<p>5000 (04/68&lt;), 5110 (&lt;07/87), 5600 (10/80&lt;), 5610 (&lt;07/87), 5900 (&lt;07/87), 6600 (&lt;09/80), 6700 (&lt;09/80)</p>
	<p><b>01F-2805Z</b></p> <p>Piston &amp; pin 020 (4.4\"/&gt; </p>	<p>5000 (04/68&lt;), 5110 (&lt;07/87), 5600 (10/80&lt;), 5610 (&lt;07/87), 5900 (&lt;07/87), 6600 (&lt;09/80), 6700 (&lt;09/80)</p>

These parts are DENVER parts and are not manufactured by the Original Equipment Manufacturer. Original Manufacturers' names, part numbers and descriptions are quoted for reference purposes only and are not intended to indicate or suggest that our parts are made by the OEM.

**01F**

Tel : +27 (31) 5692823

Page 17

Fax : +27 (31) 5692947

**01F**



	<p><b>01F-2806</b> Piston &amp; pin STD. (4.4" / 111.76mm) <i>D6NN6108Y</i> 83912026</p>	<p>7000, 7600 (&lt;10/80), 7700(&lt;10/80)</p>
	<p><b>01F-2806B</b> Piston &amp; pin 020 (4.4" / 111.76mm) <i>D6NN6108AA</i> 83912028</p>	<p>7000, 7600 (&lt;10/80), 7700(&lt;10/80)</p>
	<p><b>01F-2806C</b> Piston &amp; pin 030 (4.4" / 111.76mm) <i>D6NN6108AB</i> 83912029</p>	<p>7000, 7600 (&lt;10/80), 7700(&lt;10/80)</p>
	<p><b>01F-2807</b> Piston &amp; pin STD. (4.2" / 106.68mm) <i>D6NN6108F</i> 83910837</p>	<p>2310, 2600, 2810</p>
	<p><b>01F-2809</b> Piston &amp; pin STD. (4.2" / 106.68mm) <i>D6NN6108S</i> 83910855</p>	<p>4100</p>
	<p><b>01F-2810</b> Piston &amp; pin STD. (4.4" / 111.76mm) <i>E0NN6108AA</i> 83928178</p>	<p>4600, 4610, 4630, 6600 (10/80&lt;), 6610 (&lt;7/87), 6700 (10/80&lt;), 6710 (&lt;7/87), 7810, 7910 (4/86&lt;), 8210 (4/86&lt;), 8530 (4/86&lt;), TW5 (4/86&lt;)</p>

These parts are DENVER parts and are not manufactured by the Original Equipment Manufacturer. Original Manufacturers' names, part numbers and descriptions are quoted for reference purposes only and are not intended to indicate or suggest that our parts are made by the OEM.

**01F**

Tel : +27 (31) 5692823

Page 18

Fax : +27 (31) 5692947

**01F**

	<p><b>01F-2810B</b></p> <p>Piston &amp; pin 020 (4.4\" data-bbox="355 195 495 215"/&gt; 111.76mm)</p> <p><i>E0NN6108CA</i></p>	<p>4600, 4610, 4630, 6600 (10/80&lt;), 6610 (&lt;7/87), 6700 (10/80&lt;), 6710 (&lt;7/87), 7810, 7910 (4/86&lt;), 8210 (4/86&lt;), 8530 (4/86&lt;), TW5 (4/86&lt;)</p>
	<p><b>01F-2810C</b></p> <p>Piston &amp; pin 030 (4.4\" data-bbox="355 307 495 327"/&gt; 111.76mm)</p> <p><i>E0NN6108DA</i></p>	<p>4600, 4610, 4630, 6600 (10/80&lt;), 6610 (&lt;7/87), 6700 (10/80&lt;), 6710 (&lt;7/87), 7810, 7910 (4/86&lt;), 8210 (4/86&lt;), 8530 (4/86&lt;), TW5 (4/86&lt;)</p>
	<p><b>01F-2810D</b></p> <p>Piston &amp; pin 040 (4.4\" data-bbox="355 419 495 439"/&gt; 111.76mm)</p> <p><i>E0NN6108EA</i></p>	<p>4600, 4610, 4630, 6600 (10/80&lt;), 6610 (&lt;7/87), 6700 (10/80&lt;), 6710 (&lt;7/87), 7810, 7910 (4/86&lt;), 8210 (4/86&lt;), 8530 (4/86&lt;), TW5 (4/86&lt;)</p>
	<p><b>01F-2811</b></p> <p>Piston &amp; pin STD. (4.4\" data-bbox="355 531 495 551"/&gt; 111.76mm)</p> <p><i>E7NN6108FA</i></p> <p>83960625</p>	<p>6410, 6610 (8/87&lt;), 6710 (08/87&lt;)</p>
	<p><b>01F-2811B</b></p> <p>Piston &amp; pin 020 (4.4\" data-bbox="355 643 495 663"/&gt; 111.76mm)</p> <p><i>E7NN6108HA</i></p> <p>83960627</p>	<p>6410, 6610 (8/87&lt;), 6710 (08/87&lt;)</p>
	<p><b>01F-2811C</b></p> <p>Piston &amp; pin 030 (4.4\" data-bbox="355 755 495 775"/&gt; 111.76mm)</p> <p><i>E7NN6108JA</i></p>	<p>6410, 6610 (8/87&lt;), 6710 (08/87&lt;)</p>

These parts are DENVER parts and are not manufactured by the Original Equipment Manufacturer. Original Manufacturers' names, part numbers and descriptions are quoted for reference purposes only and are not intended to indicate or suggest that our parts are made by the OEM.

	<p><b>01F-2811D</b></p> <p>Piston &amp; pin 040 (4.4" / 111.76mm)</p> <p><i>E7NN6108KA</i></p>	<p>6410, 6610 (8/87&lt;), 6710 (08/87&lt;)</p>
	<p><b>01F-2812</b></p> <p>Piston &amp; pin STD. (4.4" / 111.76mm)</p> <p><i>D9NN6108FA</i></p> <p>83919735</p>	<p>7600 (10/80&gt;), 7700 (10/80&gt;), 7610 (&gt;7/87), 7710 (&gt;7/87)</p>
	<p><b>01F-2812B</b></p> <p>Piston &amp; pin 020 (4.4" / 111.76mm)</p> <p><i>D9NN6108HA</i></p> <p>83919737</p>	<p>7600 (10/80&gt;), 7700 (10/80&gt;), 7610 (&gt;7/87), 7710 (&gt;7/87)</p>
	<p><b>01F-2812C</b></p> <p>Piston &amp; pin 030 (4.4" / 111.76mm)</p> <p><i>D9NN6108JA</i></p>	<p>7600 (10/80&gt;), 7700 (10/80&gt;), 7610 (&gt;7/87), 7710 (&gt;7/87)</p>
	<p><b>01F-2812D</b></p> <p>Piston &amp; pin 040 (4.4" / 111.76mm)</p> <p><i>D9NN6108KA</i></p>	<p>7600 (10/80&gt;), 7700 (10/80&gt;), 7610 (&gt;7/87), 7710 (&gt;7/87)</p>
	<p><b>01F-2813</b></p> <p>Piston &amp; pin STD. (4.4" / 111.76mm)</p> <p><i>E7NN6108LA</i></p> <p>83960635</p>	<p>6810, 7410, 7610 (8/87&lt;), 7710 (8/87&lt;)</p>

These parts are DENVER parts and are not manufactured by the Original Equipment Manufacturer. Original Manufacturers' names, part numbers and descriptions are quoted for reference purposes only and are not intended to indicate or suggest that our parts are made by the OEM.



	<p><b>01F-2813B</b></p> <p>Piston &amp; pin 020 (4.4\" data-bbox="351 188 496 231"/&gt;  <i>E7NN6108NA</i></p>	<p>6810, 7410, 7610 (8/87&lt;), 7710 (8/87&lt;)</p>
	<p><b>01F-2813C</b></p> <p>Piston &amp; pin 030 (4.4\" data-bbox="351 301 496 344"/&gt;  <i>E7NN6108PA</i></p>	<p>6810, 7410, 7610 (8/87&lt;), 7710 (8/87&lt;)</p>
	<p><b>01F-2813D</b></p> <p>Piston &amp; pin 040 (4.4\" data-bbox="351 411 496 454"/&gt;  <i>E7NN6108RA</i></p>	<p>6810, 7410, 7610 (8/87&lt;), 7710 (8/87&lt;)</p>
	<p><b>01F-2900</b></p> <p>Piston ring set STD.  <i>510E6148A</i>  <i>81814624</i></p>	<p>Fordson Major (04/57&gt;12/64), Fordson Super Major (01/61&gt;12/64)</p>
	<p><b>01F-2900B</b></p> <p>Piston ring set 020  <i>510E6148B</i></p>	<p>Fordson Major (04/57&gt;12/64), Fordson Super Major (01/61&gt;12/64)</p>
	<p><b>01F-2900C</b></p> <p>Piston ring set 030</p>	<p>Fordson Major (04/57&gt;12/64), Fordson Super Major (01/61&gt;12/64)</p>

These parts are DENVER parts and are not manufactured by the Original Equipment Manufacturer. Original Manufacturers' names, part numbers and descriptions are quoted for reference purposes only and are not intended to indicate or suggest that our parts are made by the OEM.



	<p><b>01F-2900D</b> Piston ring set 040</p>	<p>Fordson Major (04/57&gt;12/64), Fordson Super Major (01/61&gt;12/64)</p>
	<p><b>01F-2901</b> Piston ring set STD. (4.2" 106.68mm) <i>DJPN6149S</i> 83917464</p>	<p>2000, 2310, 2600, 2810, 2610, 2910, 3000, 3600, 3900, 4100, 5000 (&lt;3/68), 5600 (&lt;9/80), 5700 (&lt;9/80)</p>
	<p><b>01F-2901B</b> Piston ring set 020 (4.2" 106.68mm) <i>DJPN6149T</i> 83917465</p>	<p>2000, 2310, 2600, 2810, 2610, 2910, 3000, 3600, 3900, 4100, 5000 (&lt;3/68), 5600 (&lt;9/80), 5700 (&lt;9/80)</p>
	<p><b>01F-2901C</b> Piston ring set 030 (4.2" 106.68mm) <i>DJPN6149U</i> 83917466</p>	<p>2000, 2310, 2600, 2810, 2610, 2910, 3000, 3600, 3900, 4100, 5000 (&lt;3/68), 5600 (&lt;9/80), 5700 (&lt;9/80)</p>
	<p><b>01F-2901D</b> Piston ring set 040 (4.2" 106.68mm) <i>DJPN6149V</i> 83917467</p>	<p>2000, 2310, 2600, 2810, 2610, 2910, 3000, 3600, 3900, 4100, 5000 (&lt;3/68), 5600 (&lt;9/80), 5700 (&lt;9/80)</p>
	<p><b>01F-2902</b> Piston ring set STD. (4.4" 111.76mm) <i>DJPN6149W</i> 83917468</p>	<p>3230, 3430, 3610, 3910, 3930, 4000, 4110, 4130, 4830, 4600, 4610, 4630, 5030, 5110, 5610, 5900, 5000 (4/68&lt;), 5600 (10/80&lt;) 6410 6600, 6610, 6700, 6710, 7810, 7910, 8000 (&lt;9/72), 8200, 8210 (4/86&lt;), 8530, TW5 (4/86&lt;)</p>

These parts are DENVER parts and are not manufactured by the Original Equipment Manufacturer. Original Manufacturers' names, part numbers and descriptions are quoted for reference purposes only and are not intended to indicate or suggest that our parts are made by the OEM.

**01F**

Tel : +27 (31) 5692823

Page 22

Fax : +27 (31) 5692947





**01F**



	<p><b>01F-2902B</b></p> <p>Piston ring set 020 (4.4" 111.76mm)</p> <p><i>DJPN6149X</i></p> <p>83917469</p>	<p>3230, 3430, 3610, 3910, 3930, 4000, 4110, 4130, 4830, 4600, 4610, 4630, 5030, 5110, 5610, 5900, 5000 (4/68&lt;), 5600 (10/80&lt;) 6410 6600, 6610, 6700, 6710, 7810, 7910, 8000 (&lt;9/72), 8200, 8210 (4/86&lt;), 8530, TW5 (4/86&lt;)</p>
	<p><b>01F-2902C</b></p> <p>Piston ring set 030 (4.4" 111.76mm)</p> <p><i>DJPN6149Y</i></p> <p>83917470</p>	<p>3230, 3430, 3610, 3910, 3930, 4000, 4110, 4130, 4830, 4600, 4610, 4630, 5030, 5110, 5610, 5900, 5000 (4/68&lt;), 5600 (10/80&lt;) 6410 6600, 6610, 6700, 6710, 7810, 7910, 8000 (&lt;9/72), 8200, 8210 (4/86&lt;), 8530, TW5 (4/86&lt;)</p>
	<p><b>01F-2902D</b></p> <p>Piston ring set 040 (4.4" 111.76mm)</p> <p><i>DJPN6149Z</i></p> <p>83917471</p>	<p>3230, 3430, 3610, 3910, 3930, 4000, 4110, 4130, 4830, 4600, 4610, 4630, 5030, 5110, 5610, 5900, 5000 (4/68&lt;), 5600 (10/80&lt;) 6410 6600, 6610, 6700, 6710, 7810, 7910, 8000 (&lt;9/72), 8200, 8210 (4/86&lt;), 8530, TW5 (4/86&lt;)</p>
	<p><b>01F-2903</b></p> <p>Piston ring set STD. (4.4" 111.76mm)</p> <p><i>DFPN6149E</i></p> <p>83905823</p>	<p>7000, 7600, 7700, 7610, 7710, 7910 (&lt;3/86), 8210 (&lt;3/86), 8000 (10/72&lt;), 8600, 8630, 8700, 8730, 8830, 9000, 9200, 9600, 9700, TW5 (&lt;3/86), TW10, TW15, TW20, TW25, TW30, TW35</p>
	<p><b>01F-2903B</b></p> <p>Piston ring set 020 (4.4" 111.76mm)</p> <p><i>DFPN6149B</i></p>	<p>7000, 7600, 7700, 7610, 7710, 7910 (&lt;3/86), 8210 (&lt;3/86), 8000 (10/72&lt;), 8600, 8630, 8700, 8730, 8830, 9000, 9200, 9600, 9700, TW5 (&lt;3/86), TW10, TW15, TW20, TW25, TW30, TW35</p>
	<p><b>01F-2903C</b></p> <p>Piston ring set 030 (4.4" 111.76mm)</p> <p><i>DFPN6149C</i></p>	<p>7000, 7600, 7700, 7610, 7710, 7910 (&lt;3/86), 8210 (&lt;3/86), 8000 (10/72&lt;), 8600, 8630, 8700, 8730, 8830, 9000, 9200, 9600, 9700, TW5 (&lt;3/86), TW10, TW15, TW20, TW25, TW30, TW35</p>

These parts are DENVER parts and are not manufactured by the Original Equipment Manufacturer. Original Manufacturers' names, part numbers and descriptions are quoted for reference purposes only and are not intended to indicate or suggest that our parts are made by the OEM.



	<p><b>01F-2903D</b></p> <p>Piston ring set 040 (4.4" 111.76mm)</p> <p><i>DFPN6149D</i></p> <p>83904265</p>	<p>7000, 7600, 7700, 7610, 7710, 7910 (&lt;3/86), 8210 (&lt;3/86), 8000 (10/72&lt;), 8600, 8630, 8700, 8730, 8830, 9000, 9200, 9600, 9700, TW5 (&lt;3/86), TW10, TW15, TW20, TW25, TW30, TW35</p>
	<p><b>01F-3100</b></p> <p>Semi-finished liner (4.2" 106.68mm)</p> <p><i>C5NN6055A</i></p> <p>81815327</p>	<p>2000, 2310, 2600, 2810, 2610, 2910, 3000, 3600, 3900, 4100, 5000 (&lt;3/68), 5600 (&lt;9/80), 5700 (&lt;9/80)</p>
	<p><b>01F-3100A</b></p> <p>Reborer liner 4.2 (103mm ID x 112mm OD x 279mm L)</p> <p><i>RSF41254375</i></p>	<p>2000, 2310, 2600, 2810, 2610, 2910, 3000, 3600, 3900, 4100, 5000 (&lt;3/68), 5600 (&lt;9/80), 5700 (&lt;9/80)</p>
	<p><b>01F-3101</b></p> <p>Semi-finished liner 4.4"</p> <p><i>D7NN6055A</i></p> <p><i>RSE40740</i></p>	<p>3230, 3430, 3610, 3910, 3930, 4000, 4110, 4130, 4830, 4600, 4610, 4630, 5030, 5110, 5610, 5900, 5000 (4/68&lt;), 5600 (10/80&lt;) 6410 6600, 6610, 6700, 6710, 7000, 7600, 7700, 7610, 7710, 7810, 7910, 8000, 8200, 8210, 8530, 8600, 8630, 8700, 8730, 8830, 9000, 9200, 9600, 9700, TW5, TW10, TW15, TW20, TW25, TW30, TW35</p>
	<p><b>01F-3101A</b></p> <p>Reborer liner 4.4"</p> <p><i>RSF43754625</i></p>	<p>3230, 3430, 3610, 3910, 3930, 4000, 4110, 4130, 4830, 4600, 4610, 4630, 5030, 5110, 5610, 5900, 5000 (4/68&lt;), 5600 (10/80&lt;) 6410 6600, 6610, 6700, 6710, 7000, 7600, 7700, 7610, 7710, 7810, 7910, 8000, 8200, 8210, 8530, 8600, 8630, 8700, 8730, 8830, 9000, 9200, 9600, 9700, TW5, TW10, TW15, TW20, TW25, TW30, TW35</p>
<p>NO IMAGE AVAILABLE</p>	<p><b>01F-3200</b></p> <p>Fully finished liner (1 seal groove)</p> <p><i>EIADDN6055B</i></p> <p>81710301</p>	<p>Fordson Major (&lt;2/61), Fordson Super Major (&lt;2/61)</p>

These parts are DENVER parts and are not manufactured by the Original Equipment Manufacturer. Original Manufacturers' names, part numbers and descriptions are quoted for reference purposes only and are not intended to indicate or suggest that our parts are made by the OEM.

**01F**



Tel : +27 (31) 5692823

Page 24

Fax : +27 (31) 5692947

**01F**

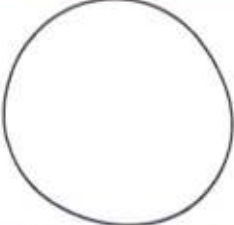





<p>NO IMAGE AVAILABLE</p>	<p><b>01F-3201</b> Fully finished liner (2 seal grooves) <i>E1ADDN6055E</i> 81710303</p>	<p>Fordson Major (2/61&gt;), Fordson Super Major (2/61&gt;)</p>
	<p><b>01F-3300</b> Bottom liner o'ring <i>116534ESA</i></p>	<p>Fordson Major, Fordson Super Major</p>
	<p><b>01F-3400</b> Top liner o'ring <i>116533ESA</i></p>	<p>Fordson Mjor, Fordson Super Major</p>
<p>NO IMAGE AVAILABLE</p>	<p><b>01F-3500</b> Crankshaft <i>E1ADDN6303F</i> 81710532</p>	<p>Fordson Major, Fordson Super Major</p>
	<p><b>01F-3502</b> Crankshaft 4.2" stroke <i>F0NN6300NA</i></p>	<p>2610, 2910, 3000 (65&lt;), 3600 (&lt;12/81), 3610, 3910 (&lt;2/90)</p>
	<p><b>01F-3503</b> Crankshaft 4.4" stroke <i>F0NN6300MA</i></p>	<p>3930, 4000, 4100, 4600, 4110, 4130, 4610, 4630</p>

These parts are DENVER parts and are not manufactured by the Original Equipment Manufacturer. Original Manufacturers' names, part numbers and descriptions are quoted for reference purposes only and are not intended to indicate or suggest that our parts are made by the OEM.

	<p><b>01F-3504</b></p> <p>Crankshaft 4.2" Stroke (78 teeth/12.5mm Gear)</p> <p><i>C5NE6303K</i></p> <p>81804029</p>	<p>5000, 5600, 5700, 6600, 6700, 6710, 7000, 7600 (01/75&gt;09/80), 7700 (01/75&gt;09/80)</p>
	<p><b>01F-3504A</b></p> <p>Crankshaft 4.2" Stroke (76 teeth)</p>	
	<p><b>01F-3506</b></p> <p>Crankshaft 4.4" Stroke (78 teeth)</p> <p><i>F0NN6300GA</i></p> <p>83918890</p>	<p>5030, 6600, 6610, 6810, 7600 (10/80&gt;12/81), 7610, 7700 (10/80&gt;12/80), 7710</p>
	<p><b>01F-3506A</b></p> <p>Crankshaft 4.4" Stroke (76 teeth)</p>	
	<p><b>01F-3552</b></p> <p>Crank seal housing (rear main)</p> <p><i>E5HN6N306AC</i></p>	<p>2310, 2600, 2610, 3600, 3610, 4100, 4110, 4600, 4610, 5600, 5610, 6600, 6610, 7600, 7610, TW5, TW10, TW15, TW20, TW25, TW30, TW35</p>
	<p><b>01F-3553</b></p> <p>Gasket for seal housing (rear main)</p> <p><i>E5HN6N305AB</i></p> <p><i>E9NN6N305AB</i></p>	<p>5900 (4/87&lt;), 5610 (4/87&lt;), 6610 (4/87&lt;), 6710 (4/87&lt;), 7610 (4/87&lt;), 7710 (4/87&lt;), 4830, 5030</p>

These parts are DENVER parts and are not manufactured by the Original Equipment Manufacturer. Original Manufacturers' names, part numbers and descriptions are quoted for reference purposes only and are not intended to indicate or suggest that our parts are made by the OEM.

	<p><b>01F-3575</b> Crank Retainer (Front) <i>C5NE6B306A</i> 8182799</p>	<p>4830, 5000, 5030, 5600, 5610, 5640, 5900, 6600, 6610, 6640, 6700, 6710, 7000, 7600, 7610, 7700, 7710, 7740, TS90, TS100, TS110</p>
	<p><b>01F-3580</b> Balancer assy (12.5mm gear 39 teeth) <i>D9NN6A311AD</i> 83924287</p>	<p>4 Cylinder models (&lt;86)</p>
	<p><b>01F-3600</b> Main bearing set STD. <i>528E6K371A</i> 81823481</p>	<p>Fordson Major, Fordson Super Major</p>
	<p><b>01F-3600A</b> Main bearing set 010 <i>528E6K371B</i> 81823482</p>	<p>Fordson Major, Fordson Super Major</p>
	<p><b>01F-3600B</b> Main bearing set 020 <i>528E6K371C</i> 81823483</p>	<p>Fordson Major, Fordson Super Major</p>
	<p><b>01F-3600C</b> Main bearing set 030 <i>528E6K371D</i> 81823484</p>	<p>Fordson Major, Fordson Super Major</p>

These parts are DENVER parts and are not manufactured by the Original Equipment Manufacturer. Original Manufacturers' names, part numbers and descriptions are quoted for reference purposes only and are not intended to indicate or suggest that our parts are made by the OEM.



	<p><b>01F-3600D</b></p> <p>Main bearing set 040</p> <p><i>528E6K371E</i></p> <p><i>81823485</i></p>	<p>Fordson Major, Fordson Super Major</p>
	<p><b>01F-3600E</b></p> <p>Main bearing set 050</p>	<p>Fordson Major, Fordson Super Major</p>
	<p><b>01F-3601</b></p> <p>Main bearing set 2-4/4610</p> <p><i>83927681 X 1</i></p> <p><i>81811583 X 3</i></p>	<p>2000, 2310, 2600, 2610, 2810, 2910, 3000, 3600, 3610, 3900, 3910, 4000, 4100, 4110, 4600, 4610</p>
	<p><b>01F-3601A</b></p> <p>Main bearing set 010</p> <p><i>83927683 X 1</i></p> <p><i>81811585 X 3</i></p>	<p>2000, 2310, 2600, 2610, 2810, 2910, 3000, 3600, 3610, 3900, 3910, 4000, 4100, 4110, 4600, 4610</p>
	<p><b>01F-3601B</b></p> <p>Main bearing set 020</p> <p><i>83927684 X 1</i></p> <p><i>81811586 X 3</i></p>	<p>2000, 2310, 2600, 2610, 2810, 2910, 3000, 3600, 3610, 3900, 3910, 4000, 4100, 4110, 4600, 4610</p>
	<p><b>01F-3601C</b></p> <p>Main bearing set 030</p> <p><i>83927685 X 1</i></p> <p><i>81811587 X 3</i></p>	<p>2000, 2310, 2600, 2610, 2810, 2910, 3000, 3600, 3610, 3900, 3910, 4000, 4100, 4110, 4600, 4610</p>

These parts are DENVER parts and are not manufactured by the Original Equipment Manufacturer. Original Manufacturers' names, part numbers and descriptions are quoted for reference purposes only and are not intended to indicate or suggest that our parts are made by the OEM.





	<p><b>01F-3601D</b></p> <p>Main bearing set 040</p> <p>83927686 X 1</p> <p>81811588 X 3</p>	<p>2000, 2310, 2600, 2610, 2810, 2910, 3000, 3600, 3610, 3900, 3910, 4000, 4100, 4110, 4600, 4610</p>
	<p><b>01F-3601E</b></p> <p>Main bearing set 050</p>	<p>2000, 2310, 2600, 2610, 2810, 2910, 3000, 3600, 3610, 3900, 3910, 4000, 4100, 4110, 4600, 4610</p>
	<p><b>01F-3602</b></p> <p>Main bearing set STD.</p> <p>83927681 X 1</p> <p>87790356 X 4</p>	<p>4830, 5000, 5030, 5110, 5600, 5610, 5700, 6410, 6600, 6610, 6700, 6710, 6810, 7000, 7600, 7610, 7700, 7710</p>
	<p><b>01F-3602A</b></p> <p>Main bearing set 010</p> <p>83927683 X 1</p> <p>81811585 X 4</p>	<p>4830, 5000, 5030, 5110, 5600, 5610, 5700, 6410, 6600, 6610, 6700, 6710, 6810, 7000, 7600, 7610, 7700, 7710</p>
	<p><b>01F-3602B</b></p> <p>Main bearing set 020</p> <p>83927684 X 1</p> <p>81811586 X 4</p>	<p>4830, 5000, 5030, 5110, 5600, 5610, 5700, 6410, 6600, 6610, 6700, 6710, 6810, 7000, 7600, 7610, 7700, 7710</p>
	<p><b>01F-3602C</b></p> <p>Main bearing set 030</p> <p>83927685 X 1</p> <p>81811587 X 4</p>	<p>4830, 5000, 5030, 5110, 5600, 5610, 5700, 6410, 6600, 6610, 6700, 6710, 6810, 7000, 7600, 7610, 7700, 7710</p>

These parts are DENVER parts and are not manufactured by the Original Equipment Manufacturer. Original Manufacturers' names, part numbers and descriptions are quoted for reference purposes only and are not intended to indicate or suggest that our parts are made by the OEM.



	<p><b>01F-3602D</b></p> <p>Main bearing set 040</p> <p>83927686 X 1</p> <p>81811588 X 4</p>	<p>4830, 5000, 5030, 5110, 5600, 5610, 5700, 6410, 6600, 6610, 6700, 6710, 6810, 7000, 7600, 7610, 7700, 7710</p>
	<p><b>01F-3602E</b></p> <p>Main bearing set 050</p>	<p>4830, 5000, 5030, 5110, 5600, 5610, 5700, 6410, 6600, 6610, 6700, 6710, 6810, 7000, 7600, 7610, 7700, 7710</p>
	<p><b>01F-3700</b></p> <p>Conrod bearing set STD.</p> <p>703F6211BAA</p> <p>81854542</p>	<p>Fordson Major, Fordson Super Major</p>
	<p><b>01F-3700A</b></p> <p>Conrod bearing set 010</p> <p>703F6244BBA</p> <p>81854543</p>	<p>Fordson Major, Fordson Super Major</p>
	<p><b>01F-3700B</b></p> <p>Conrod bearing set 020</p> <p>703F6211BCA</p> <p>81854544</p>	<p>Fordson Major, Fordson Super Major</p>
	<p><b>01F-3700C</b></p> <p>Conrod bearing set 030</p> <p>703F6211BDA</p> <p>81854545</p>	<p>Fordson Major, Fordson Super Major</p>

These parts are DENVER parts and are not manufactured by the Original Equipment Manufacturer. Original Manufacturers' names, part numbers and descriptions are quoted for reference purposes only and are not intended to indicate or suggest that our parts are made by the OEM.



	<p><b>01F-3700D</b></p> <p>Conrod bearing set 040</p> <p><i>703F6211BFA</i></p> <p><i>81854546</i></p>	<p>Fordson Major, Fordson Super Major</p>
	<p><b>01F-3700E</b></p> <p>Conrod bearing set 050</p>	<p>Fordson Major, Fordson Super Major</p>
	<p><b>01F-3701</b></p> <p>Conrod bearing set STD.</p> <p><i>DFPN6211A / B</i></p> <p><i>83906780 / 1</i></p>	<p>2000, 2310, 2600, 2610, 2810, 2910, 3000, 3600, 3610, 3900, 4000, 4100, 4110, 4600, 4610</p>
	<p><b>01F-3701A</b></p> <p>Conrod bearing set 010</p> <p><i>DFPN6211D</i></p> <p><i>83906783</i></p>	<p>2000, 2310, 2600, 2610, 2810, 2910, 3000, 3600, 3610, 3900, 4000, 4100, 4110, 4600, 4610</p>
	<p><b>01F-3701B</b></p> <p>Conrod bearing set 020</p> <p><i>DFPN6211E</i></p> <p><i>83906784</i></p>	<p>2000, 2310, 2600, 2610, 2810, 2910, 3000, 3600, 3610, 3900, 4000, 4100, 4110, 4600, 4610</p>
	<p><b>01F-3701C</b></p> <p>Conrod bearing set 030</p> <p><i>DFPN6211F</i></p> <p><i>83906785</i></p>	<p>2000, 2310, 2600, 2610, 2810, 2910, 3000, 3600, 3610, 3900, 4000, 4100, 4110, 4600, 4610</p>

These parts are DENVER parts and are not manufactured by the Original Equipment Manufacturer. Original Manufacturers' names, part numbers and descriptions are quoted for reference purposes only and are not intended to indicate or suggest that our parts are made by the OEM.



	<p><b>01F-3701D</b></p> <p>Conrod bearing set 040</p> <p><i>DFPN6211G</i></p> <p>83906789</p>	<p>2000, 2310, 2600, 2610, 2810, 2910, 3000, 3600, 3610, 3900, 4000, 4100, 4110, 4600, 4610</p>
	<p><b>01F-3701E</b></p> <p>Conrod bearing set 050</p>	<p>2000, 2310, 2600, 2610, 2810, 2910, 3000, 3600, 3610, 3900, 4000, 4100, 4110, 4600, 4610</p>
	<p><b>01F-3702</b></p> <p>Conrod bearing set STD.</p> <p><i>DFPN6211A / B</i></p> <p>83906780 / 1</p>	<p>5000, 5600, 5700, 5900, 6600, 6700</p>
	<p><b>01F-3702A</b></p> <p>Conrod bearing set 010</p> <p><i>DFPN6211D</i></p> <p>83906783</p>	<p>5000, 5600, 5700, 5900, 6600, 6700</p>
	<p><b>01F-3702B</b></p> <p>Conrod bearing set 020</p> <p><i>DFPN6211E</i></p> <p>83906784</p>	<p>5000, 5600, 5700, 5900, 6600, 6700</p>
	<p><b>01F-3702C</b></p> <p>Conrod bearing set 030</p> <p><i>DFPN6211F</i></p> <p>83906785</p>	<p>5000, 5600, 5700, 5900, 6600, 6700</p>

These parts are DENVER parts and are not manufactured by the Original Equipment Manufacturer. Original Manufacturers' names, part numbers and descriptions are quoted for reference purposes only and are not intended to indicate or suggest that our parts are made by the OEM.

**01F**

Tel : +27 (31) 5692823

Page 32

Fax : +27 (31) 5692947

**01F**

	<p><b>01F-3702D</b></p> <p>Conrod bearing set 040</p> <p><i>DFPN6211G</i></p> <p>83906786</p>	<p>5000, 5600, 5700, 5900, 6600, 6700</p>
	<p><b>01F-3702E</b></p> <p>Conrod bearing set 050</p>	<p>5000, 5600, 5700, 5900, 6600, 6700</p>
	<p><b>01F-3800</b></p> <p>Thrust washer kit (Fordson Major)</p> <p><i>E159Z9</i></p> <p>81708116</p>	<p>Fordson Major, Fordson Super Major</p>
	<p><b>01F-3800A</b></p> <p>Thrust washer 0.010</p> <p><i>E161Z9</i></p>	<p>Fordson Major, Fordson Super Major</p>
	<p><b>01F-3900</b></p> <p>Crankshaft pulley</p> <p><i>E1ADKN6312C</i></p>	<p>Fordson Major, Fordson Super Major</p>
	<p><b>01F-3901</b></p> <p>Crankshaft pulley</p> <p><i>D5NN6A312B</i></p> <p>83903706</p>	<p>2000, 2100, 2110, 2300, 2310, 2600, 2610, 3000, 3100, 3600, 3610, 4000, 4100, 4110, 4600, 4610</p>

These parts are DENVER parts and are not manufactured by the Original Equipment Manufacturer. Original Manufacturers' names, part numbers and descriptions are quoted for reference purposes only and are not intended to indicate or suggest that our parts are made by the OEM.

	<p><b>01F-3902</b></p> <p>Crankshaft pulley</p> <p><i>D5NN6A312A</i></p>	<p>5000, 5600, 5610, 6600, 6610, 6700, 6710, 7600, 7610</p>
	<p><b>01F-3910</b></p> <p>Key (Crankshaft)</p> <p>74mmx40mmx8x9</p> <p><i>C9NN6N250A</i></p>	<p>2000, 2100, 2110, 2600, 3000, 3100, 3600, 3610, 4000, 4100, 4110, 4600, 4610, 5000, 5100, 5600, 5610, 6600, 6610, 7000, 7100, 7600</p>
	<p><b>01F-3950</b></p> <p>Oil slinger (Metal)</p> <p><i>C5NE6310B</i></p> <p><i>81811428</i></p>	<p>2000, 2100, 2600, 2610, 3000, 3100, 3600, 3610, 4000, 4100, 4110, 4130, 4600, 4610, 4630, 5000, 5100, 5110, 5600, 5610, 5700, 6600, 6610, 6700, 6710, 7000, 7100, 7410, 7600, 7610, 7700, 8000, 8400, 8600, 8700, TW5, TW10, TW15, TW20, TW25, TW30, TW35</p>
	<p><b>01F-3951</b></p> <p>Oil slinger (Plastic)</p> <p><i>C5NE6310B</i></p>	<p>2000, 2100, 2600, 2610, 3000, 3100, 3600, 3610, 4000, 4100, 4110, 4130, 4600, 4610, 4630, 5000, 5100, 5110, 5600, 5610, 5700, 6600, 6610, 6700, 6710, 7000, 7100, 7410, 7600, 7610, 7700, 8000, 8400, 8600, 8700, TW5, TW10, TW15, TW20, TW25, TW30, TW35</p>
	<p><b>01F-4000</b></p> <p>Crankshaft gear</p> <p><i>EIADDN6306A</i></p> <p><i>EIADDN6306B</i></p>	<p>Fordson Major, Fordson Super Major</p>
	<p><b>01F-4001</b></p> <p>Crankshaft gear</p> <p><i>E3NN6306BA</i></p> <p><i>83943957</i></p>	<p>2000, 2310, 2600, 2610, 2810, 2910, 3000, 3230, 3430, 3600, 3610, 3910, 3930, 4000, 4100, 4110, 4130, 4600, 4610, 4630, 4830, 5000, 5030, 5110, 5600, 5610, 5700, 5900, 6410, 6600, 6610, 6700, 6710, 6810, 7000, 7410, 7600, 7610, 7700, 7710, 7810, 7910, 8000, 8200, 8210, 8530, 8600, 8630, 8700, 8730, 8830, 9000, 9200, 9600, 9700, TW5, TW10, TW15, TW20, TW25, TW30, TW35</p>

These parts are DENVER parts and are not manufactured by the Original Equipment Manufacturer. Original Manufacturers' names, part numbers and descriptions are quoted for reference purposes only and are not intended to indicate or suggest that our parts are made by the OEM.

	<p><b>01F-4100</b></p> <p>Oil pump</p> <p>528E6600</p> <p>818E6600</p>	<p>Fordson Major, Fordson Super Major</p>
	<p><b>01F-4101</b></p> <p>Oil pump</p> <p>E1NN6600DD / E1NN6600D</p> <p>81873261 / D5NN6600D</p>	<p>2000, 2100, 2110, 2120, 2150, 2300, 2310, 2600, 2610, 2810, 2910, 3000, 3055, 3100, 3120, 3150, 3190, 3230, 3300, 3310, 3400, 3430, 3500, 3550, 3600, 3610, 3630, 3910, 3930, 4000, 4100, 4110, 4130, 4140, 4190, 4200, 4330, 4340, 4400, 4410, 4500, 4600, 4600SU, 4610, 4630, 4830, 5000, 5100, 5190, 5200, 5340, 5600, 5610, 5700, 5900, 6600, County 654, 754, 764, 774</p>
	<p><b>01F-4102</b></p> <p>Oil pump (Turbo)</p> <p>E1NN6600CC</p> <p>D5NN6600C</p>	<p>5030, 5110, 6410, 6610, 6710, 6810, 7000, 7200, 7410, 7500, 7600, 7610, 7710, County 944, 964, 974</p>
	<p><b>01F-4175</b></p> <p>Check valve seat</p> <p>E1ADDN6653B</p>	<p>Fordson Major, Fordson Super Major</p>
	<p><b>01F-4300</b></p> <p>Oil pump drive shaft</p> <p>E92CP5</p>	<p>Fordson Major, Fordson Super Major</p>
	<p><b>01F-4301</b></p> <p>Oil pump drive shaft</p> <p>C7NN6A605A</p> <p>81817359</p>	<p>2000, 2310, 2600, 2610, 2810, 2910, 3000, 3230, 3430, 3600, 3630, 3910, 3930, 4000, 4100, 4110, 4130, 4600, 4610, 4630, 4830, 5000, 5030, 5110, 5600, 5610, 5700, 5900, 6410, 6600, 6610, 6700, 6710, 6810, 7000, 7410, 7600, 7610, 7700, 7710, 7810, 8000, 8200, 8600, 8700, 9000, 9200, 9600, 9700</p>

These parts are DENVER parts and are not manufactured by the Original Equipment Manufacturer. Original Manufacturers' names, part numbers and descriptions are quoted for reference purposes only and are not intended to indicate or suggest that our parts are made by the OEM.



	<p><b>01F-4400</b></p> <p>Pump gear (45 teeth)</p> <p><i>E71CP9</i></p> <p>81716968</p>	<p>Fordson Major, Fordson Super Major</p>
	<p><b>01F-4401</b></p> <p>Pump shaft and gear</p> <p><i>D3NN6A820F</i></p> <p>83984954</p>	<p>2000, 2310, 2600, 2610, 2810, 2910, 3000, 3230, 3430, 3600, 3630, 3910, 3930, 4000, 4100, 4110, 4130, 4600, 4610, 4630, 4830, 5000, 5030, 5110, 5600, 5610, 5700, 5900, 6410, 6600, 6610, 6700, 6710, 6810, 7000, 7410, 7600, 7610, 7700, 7710, 7810, 8000, 8200, 8600, 8700, 9000, 9200, 9600, 9700</p>
	<p><b>01F-4501</b></p> <p>Sump (3 cyl.)</p> <p><i>C9NN6675A</i></p>	<p>2000, 2100, 2300, 2310, 2600, 2610, 3000, 3600, 3610, 4000, 4100, 4110, 4600, 4610, 4630</p>
	<p><b>01F-4502</b></p> <p>Sump (4 cyl.)</p> <p><i>E2NN6676AA</i></p> <p><i>C9NN6676C</i></p>	<p>5000, 5030, 5600, 5610, 5700, 5900, 6410, 6600, 6610, 6700, 6710, 6810, 7000, 7410, 7600, 7610, 7700, 7710</p>
	<p><b>01F-4602</b></p> <p>Sump drain plug</p> <p><i>C9NN6730B</i></p> <p>81822147</p>	<p>2000, 2310, 2600, 2610, 2810, 2910, 3000, 3230, 3430, 3600, 3610, 3900, 3910, 3930, 4000, 4100, 4110, 4130, 4600, 4610, 4630, 4830, 5000, 5030, 5110, 5600, 5610, 5640, 5700, 5900, 6410, 6600, 6610, 6640, 6700, 6710, 6810, 7000, 7010, 7410, 7600, 7610, 7700, 7710, 7740, 7810, 7840, 8000, 8010, 8160, 8200, 8210, 8240, 8260, 8340, 8360, 8530, 8560, 8600, 8630, 8700, 8730, 8830, 9000, 9200, 9600, 9700, TM115, TM125, TM135, TM150, TM165, TS80, TS90, TS100, TS110, TS115, TW5, TW10, TW15, TW20, TW25, TW30, TW35</p>
	<p><b>01F-4700</b></p> <p>Oil cap</p> <p><i>E1ADKN6766</i></p> <p>81817845</p>	<p>Fordson Major, Fordson Super Major</p>

These parts are DENVER parts and are not manufactured by the Original Equipment Manufacturer. Original Manufacturers' names, part numbers and descriptions are quoted for reference purposes only and are not intended to indicate or suggest that our parts are made by the OEM.

**01F**

Tel : +27 (31) 5692823

Page 36

Fax : +27 (31) 5692947

**01F**





	<p><b>01F-4701</b> Oil cap <i>D0NN6766A</i> 81823295</p>	<p>2000, 3000, 4000, 5000, 7000</p>
	<p><b>01F-4702</b> Oil cap <i>D5NN6N609A</i> 83907851</p>	<p>2310, 2600, 2610, 2810, 2910, 3230, 3430, 3600, 3610, 3900, 3910, 3930, 4100, 4110, 4130, 4600, 4610, 4630, 4830, 5030, 5110, 5600, 5610, 5700, 5900, 6410, 6600, 6610, 6700, 6710, 6810, 7010, 7410, 7600, 7610, 7700, 7710, 7810, 7910, 8000, 8010, 8200, 8210, 8530, 8600, 8630, 8700, 8730, 8830, 9000, 9200, 9600, 9700, TW5, TW10, TW15, TW20, TW25, TW30, TW35</p>
	<p><b>01F-4800</b> Dipstick engine oil <i>E1ADKN6750B</i></p>	<p>Fordson Major, Fordson Super Major</p>
	<p><b>01F-4801</b> Dipstick engine oil 190mm insert <i>C5NE6750D</i> 81811440</p>	<p>2000, 2100, 2120, 2150, 2300, 2310, 3000, 3055, 3100, 3120, 3150, 3190, 3300, 3310, 3330, 3400, 3500, 4000, 4100, 4110, 4140, 4190, 4200, 4330, 4340, 4400, 4410, 4500, 5000, 5100, 5190, 5200, 5340, 5500, 6500, 7000, 7100, 7200, 7500</p>
	<p><b>01F-4802</b> Dipstick engine oil <i>E9NN6750BA</i> 83982499</p>	<p>2310, 2600, 2610, 2810, 2910, 3600, 3610, 3900, 3910, 4100, 4110, 4600, 4610, 5110, 5600, 5610, 5700, 5900, 6410, 6500, 6600, 6610, 6700, 6710, 6810, 7410, 7600, 7610, 7700, 7710, 8000, 8200, 8400, 8500, 8600, 8700, 9000, 9200, 9600, 9700, TW10, TW20, TW30</p>
	<p><b>01F-4900</b> Oil filter (Spin on) <i>E8NN6714AA</i> 83963906</p>	<p>2000 (11/69&lt;), 2310, 2600, 2610, 2810, 2910, 3000 (11/69&lt;), 3230, 3430, 3500 (11/69&lt;), 3600, 3610, 3900, 3910, 3930, 4000 (11/69&lt;), 4100, 4110, 4130, 4600, 4610, 4630, 5000 (11/69&lt;), 5110, 5530, 5600, 5610, 5700, 6000 (11/69&lt;), 6530, 6600, 6610, 6700, 6710, 7000 (11/69&lt;)</p>

These parts are DENVER parts and are not manufactured by the Original Equipment Manufacturer. Original Manufacturers' names, part numbers and descriptions are quoted for reference purposes only and are not intended to indicate or suggest that our parts are made by the OEM.



	<p><b>01F-4901</b> Oil filter (Spin on) <i>F2NN6714AB</i> 81879134</p>	<p>5610S, 5640, 6610S, 6640, 6810S, 7010, 7610S, 7740, 7810S, 7840, 8010, 8160, 8240, 8260, 8340, 8360, 8560, 8670, 8770, 8870, 8970, TM115, TM125, TM135, TM150, TM165, TS80, TS90, TS100, TS110, TS115</p>
	<p><b>01F-5000</b> Oil filter element <i>E1ADKN18662B</i> 81715758</p>	<p>Fordson Major (1956&gt;12/58)</p>
	<p><b>01F-5002</b> Oil filter element <i>DDPN6731A</i> 81837145</p>	<p>2000 (&lt;10/69), 3000 (&lt;10/69), 3500 (&lt;10/69), 4000 (&lt;10/69), 5000 (&lt;10/69), 6000 (&lt;10/69), 7000 (&lt;10/69), 8000, 8200, 8600, 8700, 9000, 9200, 9700, 9600, 9700</p>
	<p><b>01F-5200</b> Spin on mounting <i>C7NN6890A</i></p>	<p>2000, 2100, 3000, 4000, 5000, 7000</p>
	<p><b>01F-5201</b> Spin on mounting <i>D0NN6890A</i></p>	<p>2000, 2100, 2110, 2300, 2600, 2610, 2810, 2910, 3000, 3100, 3230, 3300, 3310, 3330, 3600, 3610, 3930, 4000, 4100, 4110, 4130, 4340, 4600, 4610, 4630, 4830, 5000, 5030, 5100, 5110, 5600, 5610, 5700, 6600, 6610, 6700, 6710, 6810, 7000, 7100, 7200, 7410, 7600, 7610, 7700, 7710</p>
	<p><b>01F-5600</b> Top gasket set <i>E1ADDN6C037E</i> 81708058</p>	<p>Fordson Major (52&gt;4/57)</p>

These parts are DENVER parts and are not manufactured by the Original Equipment Manufacturer. Original Manufacturers' names, part numbers and descriptions are quoted for reference purposes only and are not intended to indicate or suggest that our parts are made by the OEM.

**01F**

Tel : +27 (31) 5692823

Page 38

Fax : +27 (31) 5692947

**01F**



	<p><b>01F-5601</b> Top gasket set <i>EIADDN6C037A</i> 81743744</p>	<p>Fordson Major, Fordson Super Major (4/57&gt;8/61)</p>
	<p><b>01F-5602</b> Top gasket set <i>EIADDN6C037C</i> 81743746</p>	<p>Fordson Major, Fordson Super Major</p>
	<p><b>01F-5603</b> Top gasket set 3 cyl. (4.2")</p>	<p>2000</p>
	<p><b>01F-5604</b> Top gasket set 3 cyl.</p>	<p>4000 (&gt;5/69)</p>
	<p><b>01F-5605</b> Top gasket set 3 cyl. (4.4")</p>	<p>3230, 3430, 3610, 3910, 3930, 4000 (6/69&gt;), 4100, 4110, 4130, 4610, 4630</p>
	<p><b>01F-5606</b> Top gasket set 3 cyl.</p>	<p>2310, 2600, 2610, 2810, 2910, 3000, 3600, 3900</p>

These parts are DENVER parts and are not manufactured by the Original Equipment Manufacturer. Original Manufacturers' names, part numbers and descriptions are quoted for reference purposes only and are not intended to indicate or suggest that our parts are made by the OEM.



	<p><b>01F-5607</b> Top gasket set 4 cyl. (4.2")</p>	<p>5000 (&gt;3/68), 5600, 5700 (&gt;9/80)</p>
	<p><b>01F-5608</b> Top gasket set 4 cyl. (4.4")</p>	<p>5000 (4/68&gt;), 5600, 5700 (10/80&gt;), 4830, 5030, 5110, 5610, 5900, 6410, 6600, 6610, 6700, 6710, 6810, 7000, 7410, 7600, 7610, 7700, 7710</p>
	<p><b>01F-5609</b> Top gasket set 6 cyl.</p>	<p>8630, 8730, 8830, TW15, TW20, TW25, TW30, TW35</p>
	<p><b>01F-5610</b> Top gasket set 6 cyl (4.4")</p>	<p>7810S, 7840, 8010, 8240, 8340, TS115</p>
	<p><b>01F-5700</b> Cylinder head gasket <i>E1ADDN6051C</i> 81710277</p>	<p>Fordson Major, Fordson Super Major</p>
	<p><b>01F-5702</b> Cylinder head gasket <i>E1ADDN6051E</i> 81710281</p>	<p>Fordson Major, Fordson Super Major</p>

These parts are DENVER parts and are not manufactured by the Original Equipment Manufacturer. Original Manufacturers' names, part numbers and descriptions are quoted for reference purposes only and are not intended to indicate or suggest that our parts are made by the OEM.

	<p><b>01F-5703</b> Cylinder head gasket 4.2" 3 Cyl. <i>C7NN6051R</i> 81819540</p>	<p>2000</p>
	<p><b>01F-5704</b> Cylinder head gasket 4.4" 3 Cyl. <i>C7NN6051S</i> 81819541</p>	<p>4000 (&gt;05/69)</p>
	<p><b>01F-5705</b> Cylinder head gasket 4.4" 3 Cyl. <i>E8NN6051AA</i> 83977022</p>	<p>3230, 3430, 3610, 3910, 3930, 4000 (06/69&gt;), 4100, 4110, 4130, 4610, 4630,</p>
	<p><b>01F-5706</b> Cylinder head gasket 4.2" 3 Cyl. <i>E7NN6051DA</i> 83961551</p>	<p>2310, 2600, 2610, 2810, 2810, 2910, 3000, 3600, 3900</p>
	<p><b>01F-5707</b> Cylinder head gasket 4.2" 4 Cyl. <i>D3NN6051F</i> 81844763</p>	<p>5000 (03/68&gt;), 5600, 5700 (09/80&gt;)</p>
	<p><b>01F-5708</b> Cylinder head gasket 4.4" 4 Cyl. <i>F1NN6051BA</i> 81873577</p>	<p>4830, 5000 (04/68&gt;12/74), 5030, 5110, 5610, 5640, 5900, 6410, 6600, 6610, 6640, 6700, 6710, 6810, 7000, 7600, 7610, 7700, 7710, 7740, TS80, TS90, TS100, TS110</p>

These parts are DENVER parts and are not manufactured by the Original Equipment Manufacturer. Original Manufacturers' names, part numbers and descriptions are quoted for reference purposes only and are not intended to indicate or suggest that our parts are made by the OEM.



# DENVER

	<p><b>01F-5709</b> Cylinder head gasket 6 Cyl. <i>E9NN6051AA</i> 83982125</p>	<p>7810, 7910, 8210, 8530, 8630, 8700, 8730, 8830, 9700, TW5, TW10, TW15, TW20, TW25, TW30, TW35,</p>
	<p><b>01F-5710</b> Cylinder head gasket 4.4\" 6cyl. <i>E9NN6051BA</i> 83982127</p>	<p>7810S, 7840, 8000, 8010, 8160, 8200, 8240, 8260, 8340, 8600, TS115, TM115</p>
	<p><b>01F-5800</b> Exhaust manifold gasket</p>	<p>Fordson Major, Fordson Super Major</p>
	<p><b>01F-5801</b> Exhaust man. gasket (use 1 for 3cyl &amp; 2 for 6cyl) <i>E8NN9448AA</i> 83981486</p>	<p>2310, 2600, 2610, 2810, 2910, 3230, 3430, 3600, 3610, 3910, 3930, 4100, 4110, 4130, 4600, 4610, 4630, 7810, 7910, 8000, 8200, 8210, 8530, 8600, 8630, 8700, 8730, 8830, 9000, 9200, 9600, 9700, TW5, TW10, TW15, TW20, TW25, TW30, TW35</p>
	<p><b>01F-5802</b> Exhaust manifold gasket <i>E8NN9448BA</i> 83983680</p>	<p>4830, 5000, 5030, 5110, 5600, 5610, 5700, 5900, 6410, 6600, 6610, 6700, 6710, 6810, 7000, 7600, 7610, 7700, 7710</p>
	<p><b>01F-5900</b> Intake manifold gasket</p>	<p>Fordson Major, Fordson Super Major</p>

These parts are DENVER parts and are not manufactured by the Original Equipment Manufacturer. Original Manufacturers' names, part numbers and descriptions are quoted for reference purposes only and are not intended to indicate or suggest that our parts are made by the OEM.







**01F**

Tel : +27 (31) 5692823

Page 42

Fax : +27 (31) 5692947





**01F**

	<p><b>01F-5901</b> Intake manifold gasket (round port) <i>C7NN9439B</i></p>	<p>2000, 3000, 4000</p>
	<p><b>01F-5902</b> Intake manifold gasket (square port) <i>D3NN9439A</i> <i>E8NN9439AA</i></p>	<p>2600, 3600, 3610, 4100, 4110, 4600, 4610</p>
	<p><b>01F-5903</b> Intake manifold gasket (Square) <i>C7NN9439C</i></p>	<p>5000, 7000, 5600</p>
	<p><b>01F-5904</b> Intake manifold gasket (Round) <i>E6NN9439AA</i> <i>E6NN9439AB</i></p>	<p>5610, 6600, 6610, 6700, 6710, 7600, 7610, 7700, 7710</p>
	<p><b>01F-5905</b> Intake manifold gasket <i>E7NN9439EA</i></p>	<p>8210, TW15, TW25, TW35</p>
	<p><b>01F-6000</b> Rocker cover gasket <i>E1ADKN6584A</i></p>	<p>Fordson Major, Fordson Super Major</p>

These parts are DENVER parts and are not manufactured by the Original Equipment Manufacturer. Original Manufacturers' names, part numbers and descriptions are quoted for reference purposes only and are not intended to indicate or suggest that our parts are made by the OEM.

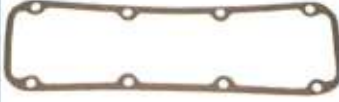

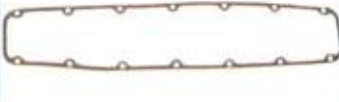
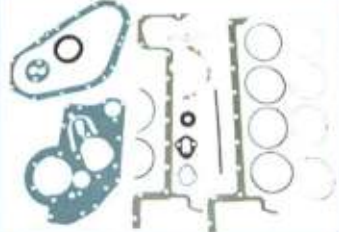
# DENVER

	<p><b>01F-6001</b> Rocker cover gasket <i>C7NN6584B</i> 81817048</p>	<p>2000, 2310, 2600, 2610, 2810, 2910, 3000, 3600, 3610, 3900, 3910, 3910H, 4000, 4100, 4110, 4600, 4610, 4610H,</p>
	<p><b>01F-6002</b> Rocker cover gasket <i>C7NN6584C</i> 81817049</p>	<p>4830, 5000 (4/68&lt;), 5030, 5110, 5600, 5610, 5700 (10/80&lt;), 5900, 6410, 6600, 6610, 6700, 6710, 6810, 7000, 7410, 7600, 7610, 7700, 7710</p>
	<p><b>01F-6003</b> Rocker cover gasket <i>D8NN6584AA</i> 83912957</p>	<p>7810, 7910, 8000, 8200, 8210, 8530, 8600, 8630, 8700, 8730, 8830, 9000, 9200, 9600, 9700, TW5, TW10, TW15, TW20, TW25, TW30, TW35</p>
	<p><b>01F-6100</b> Bottom gasket set <i>E1ADDN6013C</i></p>	<p>Fordson Major, Fordson Super Major</p>
	<p><b>01F-6101</b> Bottom gasket set <i>EAPN6A008A</i> 83926004</p>	<p>2000, 2310, 2600, 2610, 2810, 2910, 3000, 3600, 3610, 3900, 3910, 3910H, 4000, 4100, 4110, 4600, 4610, 4610H,</p>
	<p><b>01F-6102</b> Bottom gasket set <i>CFPN6A008C</i> 81813951</p>	<p>5000, 5110, 5600, 5610, 5700, 5900, 6410, 6600, 6610, 6700, 6710, 6810, 7000, 7410, 7600, 7610, 7700, 7710,</p>

These parts are DENVER parts and are not manufactured by the Original Equipment Manufacturer. Original Manufacturers' names, part numbers and descriptions are quoted for reference purposes only and are not intended to indicate or suggest that our parts are made by the OEM.

**01F**

Tel : +27 (31) 5692823

Page 44

Fax : +27 (31) 5692947

**01F**





# DENVER

	<p><b>01F-6103</b> Bottom gasket set <i>ECPN6A008AA</i> 83933429</p>	<p>7810, 7910, 8210, 8530, 8630, 8730, 8830, TW5, TW10, TW15, TW20, TW25, TW30, TW35</p>
	<p><b>01F-6200</b> Front timing seal <i>510E6362</i> 81710683</p>	<p>Fordson Major, Fordson Super Major</p>
	<p><b>01F-6201</b> Front housing seal <i>F0NN6700CA</i> 81815927</p>	<p>2000, 2310, 2600, 2610, 2810, 2910, 3000, 3230, 3430, 3600, 3610, 3910, 3930, 4000, 4100, 4110, 4230, 4600, 4610, 4630, 4830, 5000, 5030, 5110, 5600, 5610, 5610S, 5640, 5700, 5900, 6410, 6600, 6610, 6610S, 6640, 6700, 6710, 6810, 6810S, 7000, 7010, 7410, 7600, 7610, 7610S, 7700, 7710, 7740, 7810, 7810S, 7840, 8000, 8160, 8200, 8210, 8240, 8340, 8530, 8560, 8600, 8630, 8700, 8730, 8770, 8830, 9000, 9200, 9600, 9700, TS80, TS90, TS100, TS110, TS115 TW5, TW10, TW15, TW20, TW25, TW30, TW35, TM115, TM125, TM135, TM150, TM165,</p>
	<p><b>01F-6300</b> Rear main rope seal <i>793F6701AAA</i> 81854827</p>	<p>Fordson Major, Fordson Super Major</p>
	<p><b>01F-6301</b> Rear main oil seal <i>D8NN6701BA</i> 83916918</p>	<p>2000, 2310, 2600, 2610, 2810, 2910, 3000, 3230, 3430, 3600, 3610, 3910, 3930, 4000, 4100, 4110, 4230, 4600, 4610, 4630, 4830, 5000, 5030, 5110, 5600, 5610, 5610S, 5640, 5700, 5900, 6410, 6600, 6610, 6610S, 6640, 6700, 6710, 6810, 6810S, 7000, 7010, 7410, 7600, 7610, 7610S, 7700, 7710, 7740, 7810, 7810S, 7840, 7910, 8000, 8200, 8210, 8240, 8340, 8530, 8600, 8630, 8670, 8700, 8730, 8770, 8830, 9000, 9200, 9600, 9700, TS80, TS90, TS100, TS110, TS115 TW5, TW10, TW15, TW20, TW25, TW30, TW35, TM115, TM125, TM135, TM150, TM165,</p>
	<p><b>01F-6400</b> Sump gasket <i>E1ADKN6675G</i></p>	<p>Fordson Major, Fordson Super Major</p>

These parts are DENVER parts and are not manufactured by the Original Equipment Manufacturer. Original Manufacturers' names, part numbers and descriptions are quoted for reference purposes only and are not intended to indicate or suggest that our parts are made by the OEM.

**01F**

Tel : +27 (31) 5692823

Page 45

Fax : +27 (31) 5692947

**01F**



	<p><b>01F-6401</b> Sump gasket 3 Cyl. <i>F0NN6710AA</i> 83990594</p>	<p>2000, 2310, 2600, 2610, 2810, 2910, 3000, 3230, 3430, 3600, 3610, 3900, 3910, 3910H, 3930, 3930H, 4000, 4100, 4110, 4130, 4600, 4610, 4610H, 4630</p>
	<p><b>01F-6402</b> Sump gasket 4 Cyl. <i>E9NN6710BA</i> 87840324</p>	<p>4830 (07/90&gt;05/94), 5000, 5030, 5110, 5600, 5610, 5640, 5700, 5900, 6410, 6600, 6610, 6640, 6700, 6710, 6810, 7000, 7600, 7610, 7700, 7710, 7740, TS80 (Powerstar 5.0), TS90 (Powerstar 5.0), TS100 (Powerstar 5.0T), TS110 (Powerstar 5.0T)</p>
	<p><b>01F-6403</b> Sump gasket 6 Cyl. <i>E9NN6710DB</i> 87840326</p>	<p>7810, 7810S, 7840, 7910, 8000, 8010, 8160, 8200, 8210, 8240, 8260, 8340, 8360, 8530, 8560, 8600, 8630, 8730, 8830, TW5, TW10, TW15, TW20, TW25, TW30, TW35, TS115, TM115, TN125, TM135, TM150, TM165</p>

These parts are DENVER parts and are not manufactured by the Original Equipment Manufacturer. Original Manufacturers' names, part numbers and descriptions are quoted for reference purposes only and are not intended to indicate or suggest that our parts are made by the OEM.

**01F**

**Tel : +27 (31) 5692823**

**Page 46**

**Fax : +27 (31) 5692947**

**01F**